

# SG 7640

---

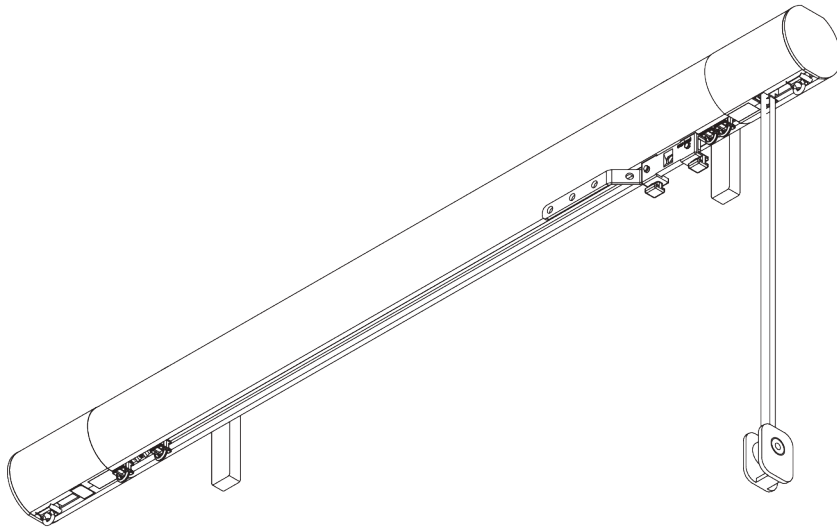
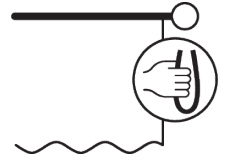

## PRODUCT INFORMATION

- **Operation:** cord
- **Range:** M - L
- **Fitting:** ceiling, wall
- **Colours:** white RAL 9016, various colours / finishes
- **Fabrics:** refer to Silent Gliss fabric collection

### **Features:**

- 2-component (2C) glider technology
- Wave (2C)
- Matching endcaps and brackets / bracket covers
- Range of decorative finials
- Bendable

# SYSTEM SPECIFICATIONS

## A. SYSTEM DIMENSIONS



6 m

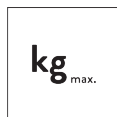

13 kg

## Max. curtain weights

	Standard Application with Glider						Standard Application with Roller/ Wave Roller					
	1 m	2 m	3 m	4 m	5 m	6 m	1 m	2 m	3 m	4 m	5 m	6 m
	9	9	8	8	7	7	12	11	11	11	10	10
	10	10	9	9	8	8	13	13	12	11	11	10
	7	7	6	6	5	5	9	8	8	8	7	7
	8	8	7	7	6	6	10	9	9	9	8	8
	4	4	3	3	2	2	6	5	5	5	4	4
	5	5	4	4	3	3	7	6	6	6	5	5
	3	3	2	2	1	1	5	4	4	4	3	3
	4	4	3	3	2	2	6	5	5	5	4	4

(kg max.)

## B. PROFILE

### Profile and bending informationn

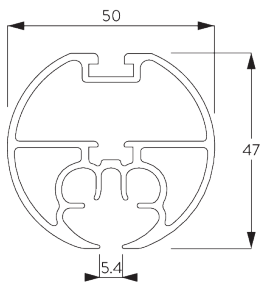

SG 11607

Profile

Radius:  
✓ >68 cm

**C. HOW TO  
MEASURE**

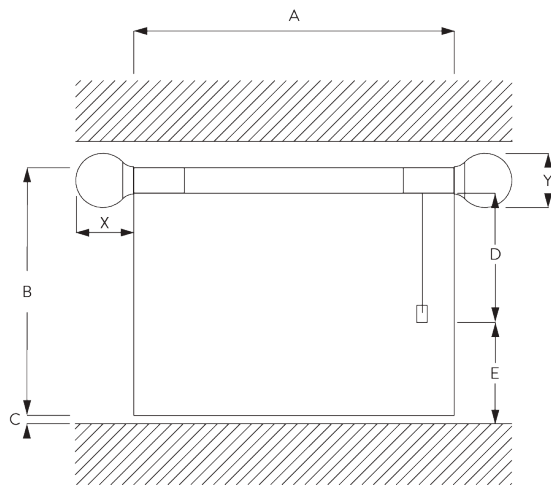

- A: System width without finials
- B: System height
- C: Distance between floor and fabric
- D: Cord height
- E: Safety Retainer SG 10731 min. 150 cm above floor
- X: Finial width
- Y: Finial height

**Finial Measurements**

		50 mm	
		X	Y
	SG 11605	2	51
	SG 11651	10	56
	SG 11652	24	75
	SG 11753	115	51
	SG 11754	83	70
	SG 11756	90	85
	SG 11757	165	70
	SG 11758	32	130
	SG 11759	30	100

## D. SPECIFICATION

### TEXT

**Silent Gliss SG 7640 'Metropole' cord operated curtain track system.** Comprises 50 mm aluminium profile SG 11607 supplied made to measure with 2C gliders SG 11300 at 14/m, 2 no. flush end covers SG 11605, cording set SG 20347, overlap SG 6063 and cord SG 3091. Supplied as standard with wall 'face' fix Maxi brackets SG 20334 at max. 600 mm centres. Optional wall fix brackets SG 11206-11208 / SG 11216-11218 / SG 11209 / SG 11472 / Fillet bracket SG 11669. Bent systems for wall 'face' fix supplied as standard with adjustable Smart Fix bracket SG 11209. Ceiling 'top' fix with plate SG 6151 / bracket SG 6175 / SG 11668 at max. 600 mm centres. Finished in Black, White, Matt White, Ecru, Slate Grey, Bronze, Antique Bronze, Anodic Grey and Taupe. A range of decorative finials are available. Silent Gliss Wave option is available using 60 mm glider cord SG 11303 / 80mm glider cord SG 11302 / 80 mm roller glider cord SG 6099. Compliant to Child Safety legislation EN 13120.

# FITTING

## A. FITTING INFORMATION

For detailed fitting information, visit the [Silent Gliss website](#).

### Fixing points

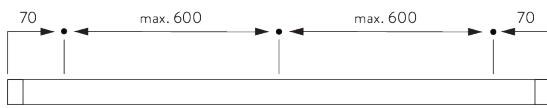

## B. CEILING FITTING

### Support SG 6152

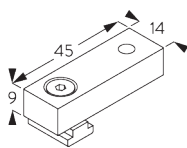
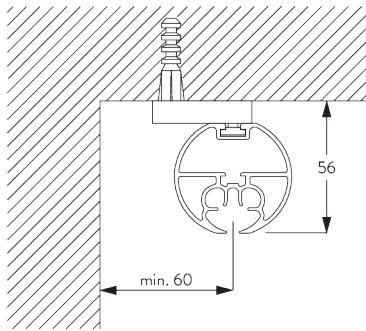

### SG 6152

Ceiling support set 9 mm

### Top fix bracket SG 11668

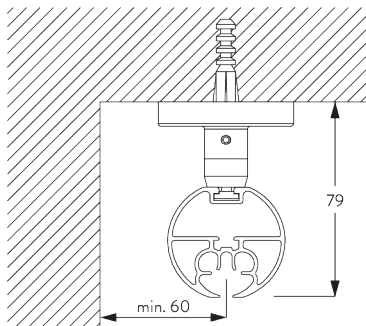

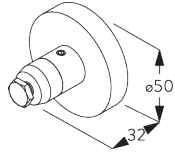

**SG 11668**  
Top fix bracket

**Mini hanger SG 6175**

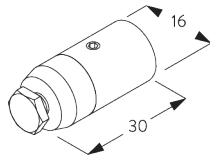
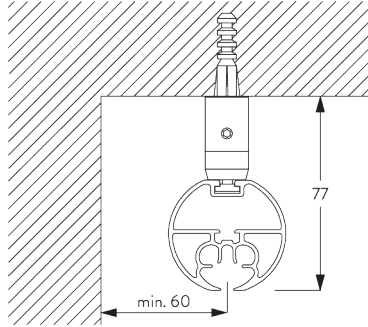

**SG 6175**  
Mini hanger

**C. WALL FITTING**

**Smart Fix**

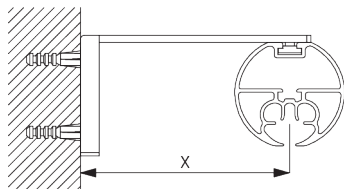

**Smart Fix with slot SG 11206 - SG 11208 and SG 6141:**  
Screw SG 6783 (M4x10) needed.

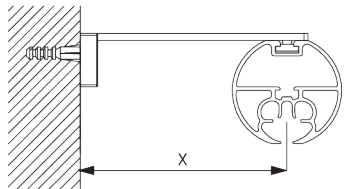

**Square Smart Fix with slot SG 11216 - SG 11218 and SG 6141:**  
Screw SG 6783 (M4x10) needed.

Smart Fix	X mm
SG 11206 / SG 11216	51
SG 11207 / SG 11217	71
SG 11208 / SG 11218	91
SG 11209 / SG 11472	80-100

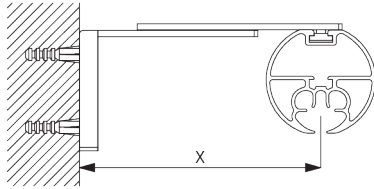

**Adjustable Smart Fix SG 11209 and SG 6141:**  
Screw SG 6784 (M4x8) needed.

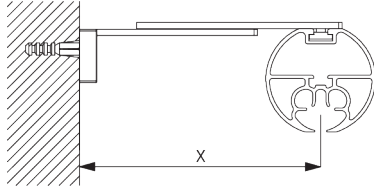

**Adjustable Square Smart Fix SG 11472 and SG 6141:**  
Screw SG 6784 (M4x8) needed.

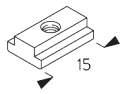

**SG 6141**  
Clamping piece



**SG 6783**  
Hexagon socket countersunk screw M4x10 mm



**SG 6784**  
Hexagon socket countersunk screw M4x8 mm

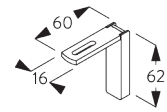

**SG 11206**  
Smart Fix with slot 60 mm

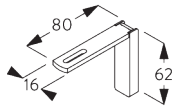

**SG 11207**  
Smart Fix with slot 80 mm

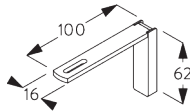

**SG 11208**  
Smart Fix with slot 100 mm

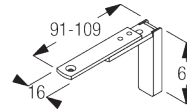

**SG 11209**  
Adjustable Smart Fix

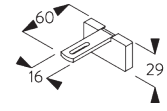

**SG 11216**  
Square Smart Fix with slot 60 mm

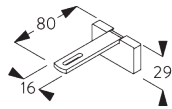

**SG 11217**  
Square Smart Fix with slot 80 mm

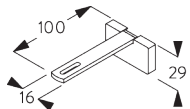

**SG 11218**  
Square Smart Fix with slot 100 mm

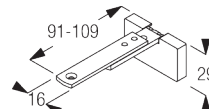

**SG 11472**  
Adjustable Square Smart Fix

**Fillet Bracket  
SG 11669**

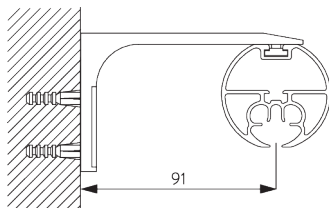

Screw SG 6784 (M4x8) needed.  
Recommended for straight systems only.

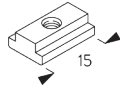

**SG 6141**

Clamping piece



**SG 6784**

Hexagon socket countersunk screw M4x8 mm

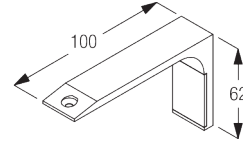

**SG 11669**

Fillet bracket

### Maxi adjustable bracket SG 20334

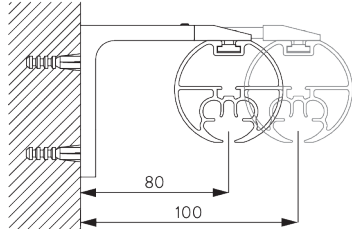

Screw SG 6783 (M4x10) needed.

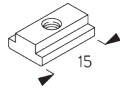

**SG 6141**

Clamping piece



**SG 6783**

Hexagon socket countersunk screw M4x10 mm

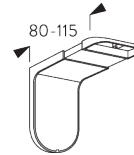

**SG 20334**

Maxi adjustable bracket

## DESIGN & SYSTEM OPTIONS

### A. ENDCAPS



SG 11605



SG 11651



SG 11652

Endcaps:

- SG 11605 Flush endcap 50 mm
- SG 11651 Stud endcap 50 mm
- SG 11652 Design endcap 50 mm

Please note:

- Without finials, poles are supplied as standard with flush fitting endcaps SG 11605 (left).
- Alternatively, stud endcaps SG 11651 can be selected at no additional cost.

## **B. FINIALS**

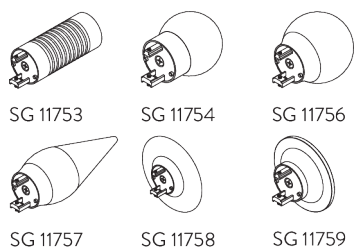

Finials are decorative elements that fit on at the end of the pole:

- SG 11753 Groove cylinder 50 mm
- SG 11754 Glass ball 50 mm
- SG 11756 Ball end 50 mm
- SG 11757 Spear 50 mm
- SG 11758 Ellipse 50 mm
- SG 11759 Taper 50 mm

## **C. WAVE**

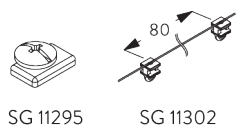
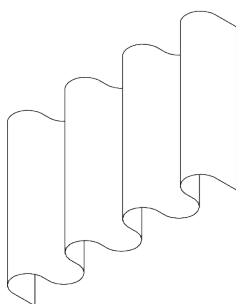

Standard components:

- SG 11295 End stop
- SG 11302 Wave 2C glider cord 80 mm

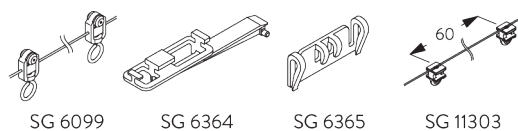

Optional component:

- SG 6099 Wave roller cord 80 mm
- SG 6364 Wave extension
- SG 6365 Wave hanger
- SG 11303 Wave 2C glider Cord 60 mm

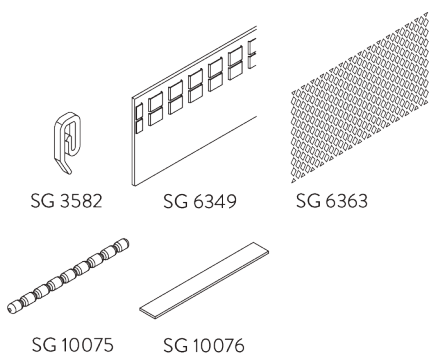

Curtain components:

- SG 3582 Hook
- SG 6349 Wave curtain tape
- SG 6363 Wave top hemming tape
- SG 10075 Lead weight 50 gr/m
- SG 10076 Fabric weigh



Wave stack depth - 2C glider cord (standard components)

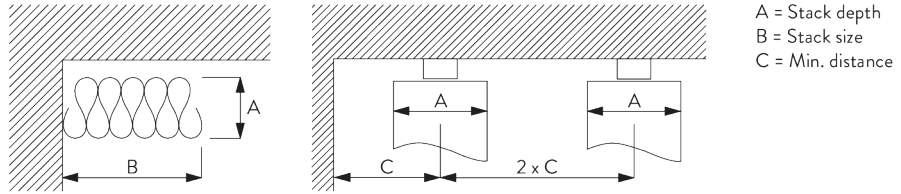

2C Glider cord SG 11302	Pockets between hooks	Approx. curtain fullness	Stack depth A	Stack size B*	Min distance C
80	6	~2.1	140	180 per metre of track	90
80	7	~2.3	160	180 per metre of track	100

2C Glider cord SG 11303	Pockets between hooks	Approx. curtain fullness	Stack depth A	Stack size B*	Min distance C
60	4	~2.1	100	230 per metre of track	70
60	5	~2.3	120	230 per metre of track	80

\*Stack size B when using optional extension arm SG 6364 increases by 175 mm per curtain stack!

# PARTS

## A. STANDARD PARTS

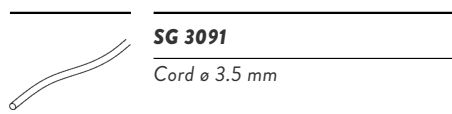

**SG 3091**  
Cord ø 3.5 mm

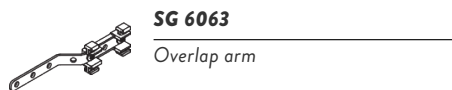

**SG 6063**  
Overlap arm



**SG 6065**  
End stop

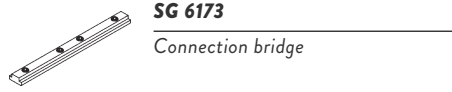

**SG 6173**  
Connection bridge

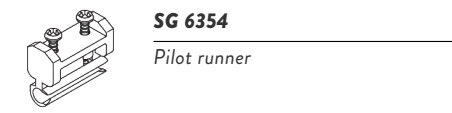

**SG 6354**  
Pilot runner

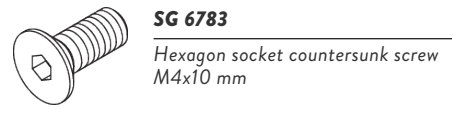

**SG 6783**  
Hexagon socket countersunk screw  
M4x10 mm

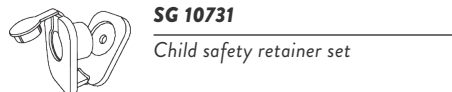

**SG 10731**  
Child safety retainer set

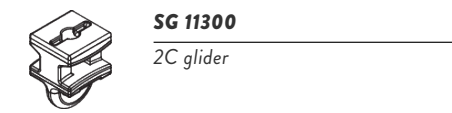

**SG 11300**  
2C glider

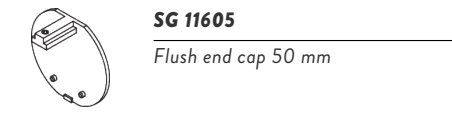

**SG 11605**  
Flush end cap 50 mm

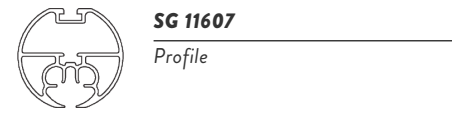

**SG 11607**  
Profile

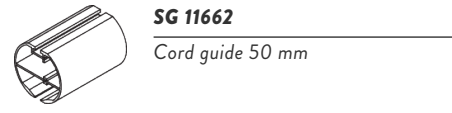

**SG 11662**  
Cord guide 50 mm

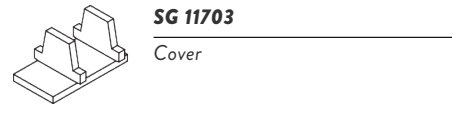

**SG 11703**  
Cover

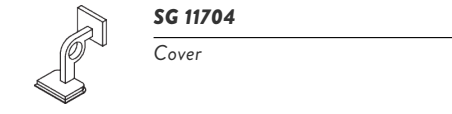

**SG 11704**  
Cover

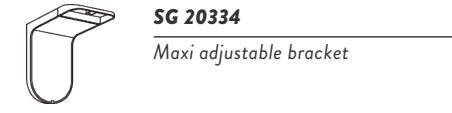

**SG 20334**  
Maxi adjustable bracket

## B. OPTIONAL PARTS



**SG 3582**  
Hook

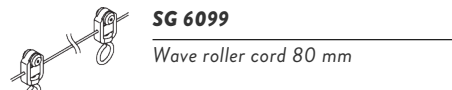

**SG 6099**  
Wave roller cord 80 mm

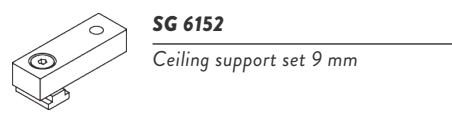

**SG 6152**  
Ceiling support set 9 mm

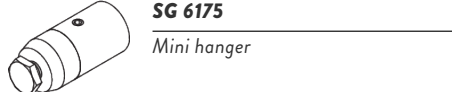

**SG 6175**  
Mini hanger

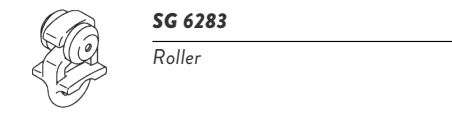

**SG 6283**  
Roller

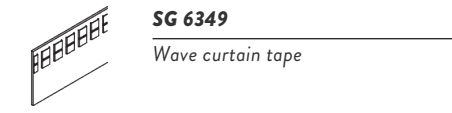

**SG 6349**  
Wave curtain tape

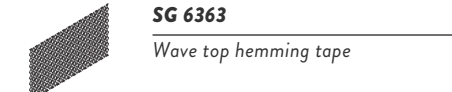

**SG 6363**  
Wave top hemming tape

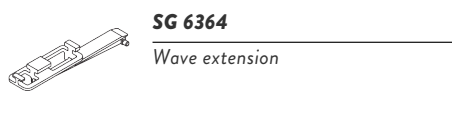

**SG 6364**  
Wave extension

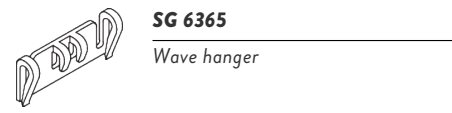

**SG 6365**  
Wave hanger

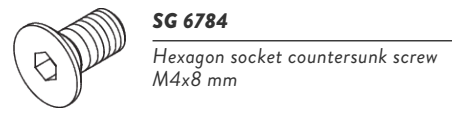

**SG 6784**  
Hexagon socket countersunk screw  
M4x8 mm

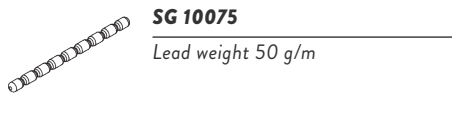

**SG 10075**  
Lead weight 50 g/m

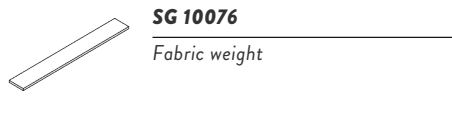

**SG 10076**  
Fabric weight

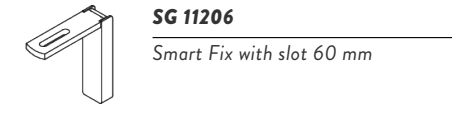

**SG 11206**  
Smart Fix with slot 60 mm

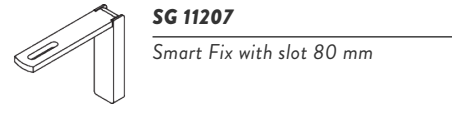

**SG 11207**  
Smart Fix with slot 80 mm

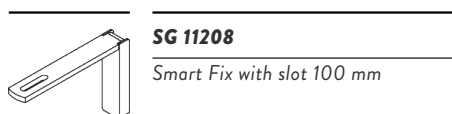

**SG 11208**  
Smart Fix with slot 100 mm

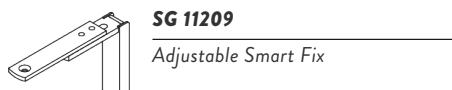

**SG 11209**  
Adjustable Smart Fix

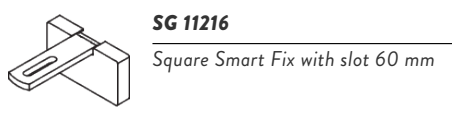

**SG 11216**  
Square Smart Fix with slot 60 mm

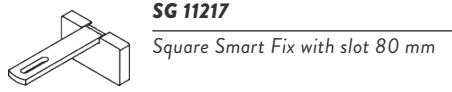

**SG 11217**  
Square Smart Fix with slot 80 mm

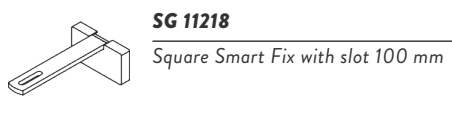

**SG 11218**  
Square Smart Fix with slot 100 mm

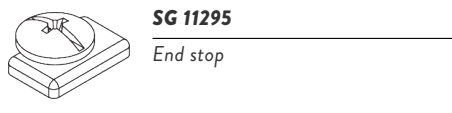

**SG 11295**  
End stop

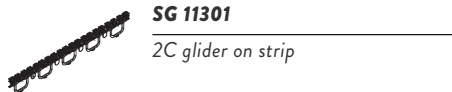

**SG 11301**  
2C glider on strip

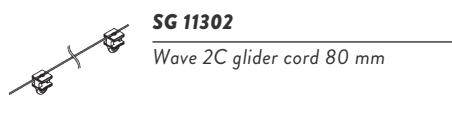

**SG 11302**  
Wave 2C glider cord 80 mm

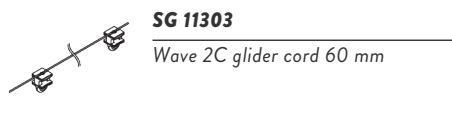

**SG 11303**  
Wave 2C glider cord 60 mm

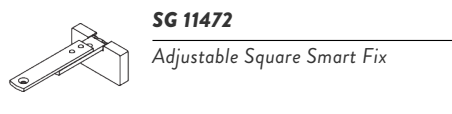

**SG 11472**  
Adjustable Square Smart Fix

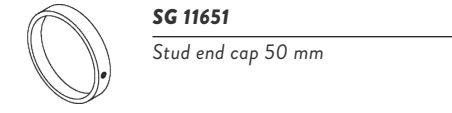

**SG 11651**  
Stud end cap 50 mm

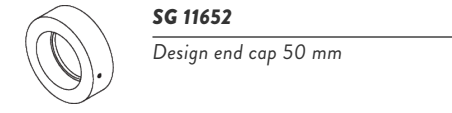

**SG 11652**  
Design end cap 50 mm

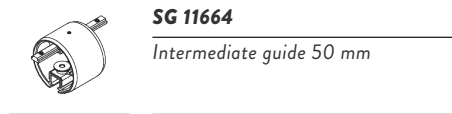

**SG 11664**  
Intermediate guide 50 mm

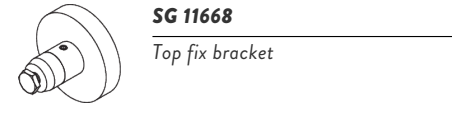

**SG 11668**  
Top fix bracket

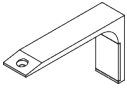

---

**SG 11669**  
*Fillet bracket*

---

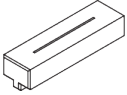

---

**SG 11702**  
*Connection bridge*

---

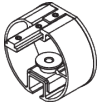

---

**SG 11717**  
*Wave single stack return pulley 50 mm*

---

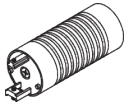

---

**SG 11753**  
*Groove cylinder 50 mm*

---

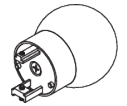

---

**SG 11754**  
*Glass ball 50 mm*

---

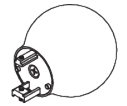

---

**SG 11756**  
*Ball end 50 mm*

---



---

**SG 11757**  
*Spear 50 mm*

---

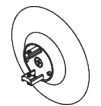

---

**SG 11758**  
*Ellipse 50 mm*

---

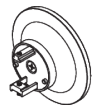

---

**SG 11759**  
*Taper 50 mm*

---