

Silent Gliss 6370 Fitting Instructions

Includes:

- Ceiling Fix
- Wall Fix



Ceiling Fix

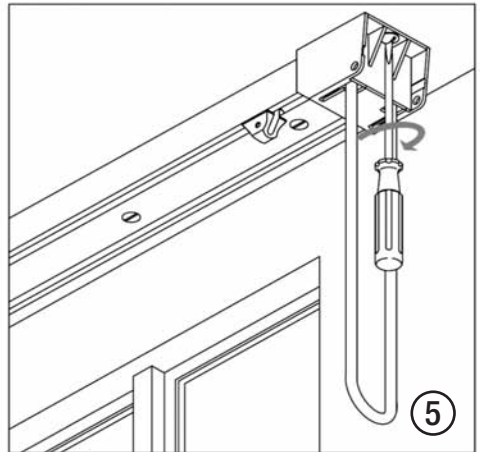
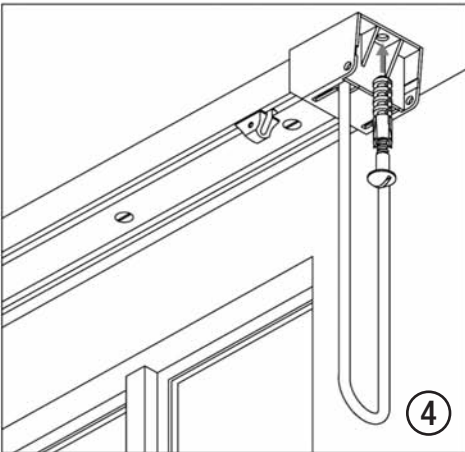
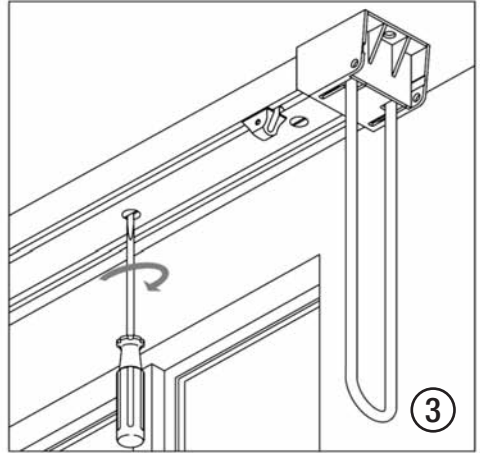
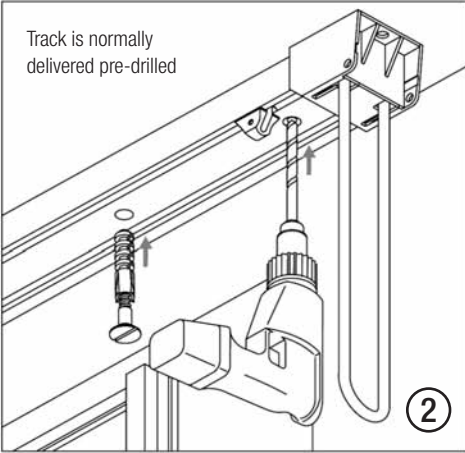
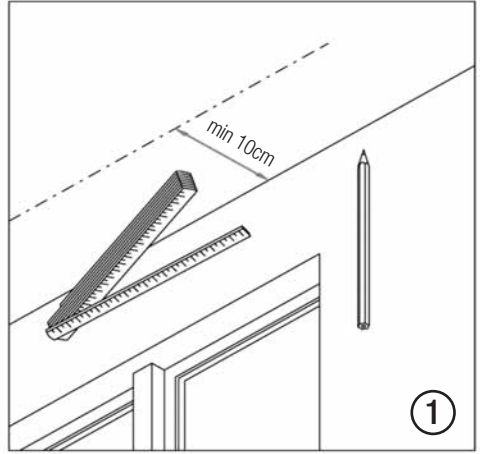
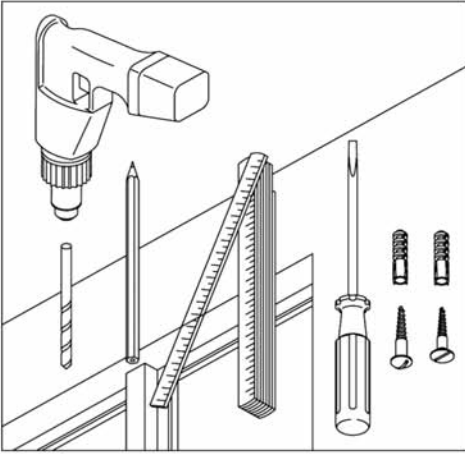

Wall Fix

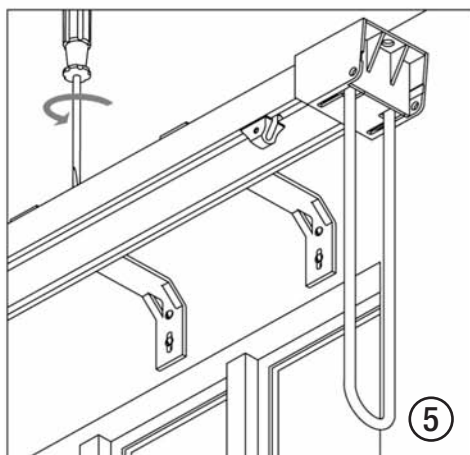
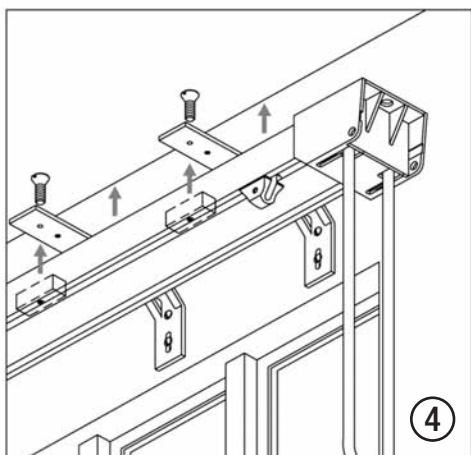
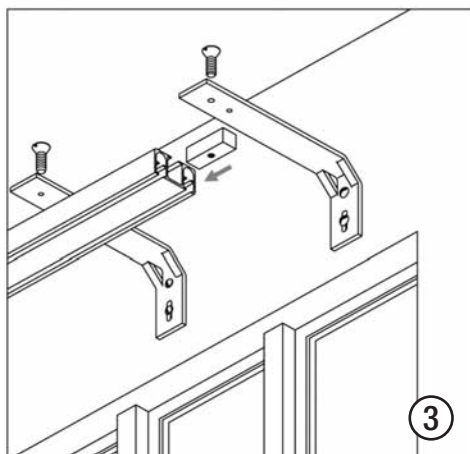
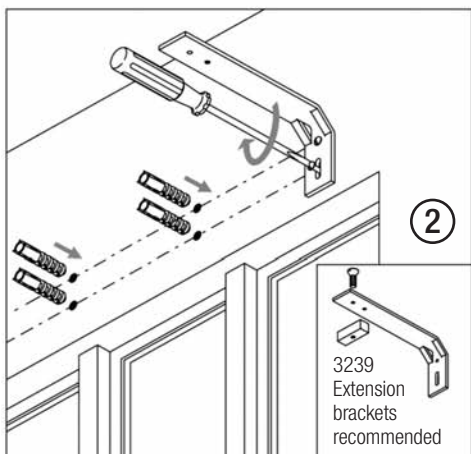
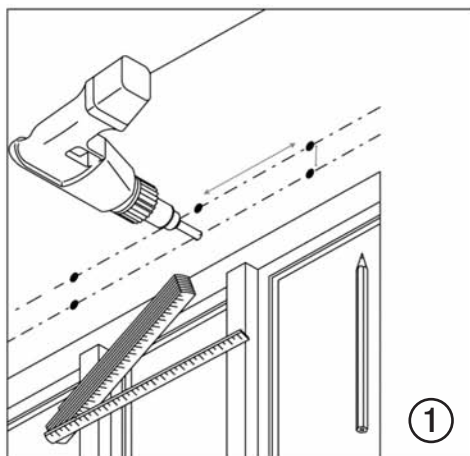
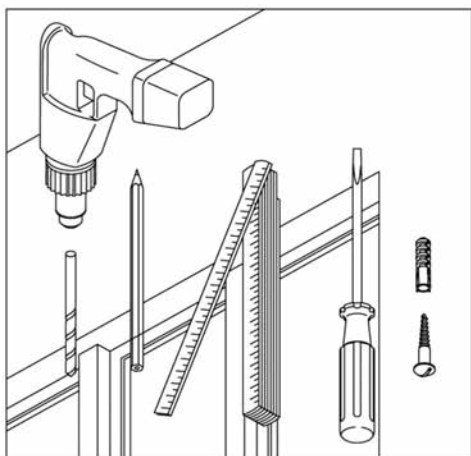

WARNING

Young children can be strangled by loops in pullcords, chains, tapes and inner cords that operate the product. To avoid strangulation and entanglement, keep cords out of the reach of young children. Cords may become wrapped around a child's neck. Move beds, cots and furniture away from window covering cords. Do not tie cords together. Make sure cords do not twist and create a loop.

TWISSIJA

It-tfal żgħar jistgħu jitgħallqu minħabba f'għoqod fil-kurduni tal-ġbid, fil-ktajjen, fit-tejps u fil-kurduni interni li jħaddmu l-prodott. Biex tevita tghallieq u taħbil, żomm il-kurduni 'l bogħod mit-tfal. Hemm ċans li l-kurduni jitgeżwru madwar għonq it-tfal. Ressaq kwalunkwe sodod, benniena u għamara 'l bogħod mill-kurduni tal-blajnds. Torbotx il-kurduni flimkien. Kun ċert li l-kurduni ma jithabblux u joħolqu għolqa.

UYARI

Küçük çocuklar, ürünü çalıştıran çekme kordonları, zincirler, bantlar ya da iç kısımlardaki iplerdeki döngüler nedeniyle boğulabilirler. Boğulma ve dolanmanın önlenmesi için kordonları küçük çocukların ulaşamayacağı yerlerde tutunuz. Kordonlar çocuğun boynuna sarılabilir. Yatakları, beşikleri/karyoları ve eşyaları, pencereleri kaplayan kordonlardan uzağa taşıyın. Kordonları birbirine bağlamayın. Kordonların kıvrılıp döngü oluşturmadığından emin olun.

ΠΡΟΕΙΔΟΠΟΙΗΣΗ

Μικρά παιδιά μπορούν να στραγγαλιστούν από θηλιές σε κορδόνια έλξης, αλυσίδες, ταινίες και εσωτερικά κορδόνια με τα οποία λειτουργεί το προϊόν. Για την αποφυγή στραγγαλισμού και πνιγμού, τα κορδόνια πρέπει να βρίσκονται μακριά από μικρά παιδιά. Τα κορδόνια μπορεί να τυλιχθούν γύρω από το λαιμό του παιδιού. Μετακινήστε κρεβάτια, παιδικά κρεβάτια και έπιπλα μακριά από τα κορδόνια χειρισμού των κουρτινών.



Silent Gliss Cord Retainer

Children can strangle if this safety device is not installed. Always use this device to keep cords and chains out of reach of children.

Fixing instruction for the device

This retaining device should be installed at the maximum distance possible from the control mechanism to prevent the looped pull cord(s) becoming slack.

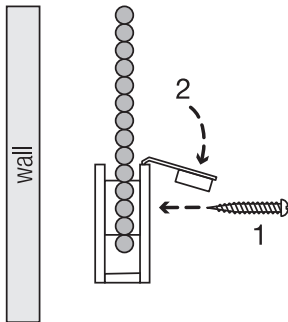

It-tfal jistgħu jitgħallqu jekk dan it-tagħmir ta' sigurtà ma jiġix installat. Dejjem uża dan ittagħmir biex iżzomm il-kurduni u l-ktajjen 'il bogħod mit-tfal.

Struzzjonijiet biex jitwaħħal it-tagħmir

Dan it-tagħmir tal-irbit għandu jiġi installat kemm jista' jkun 'il bogħod mill- mekkanizmu ta' kontroll sabiex jiġi evitat li l-kurdun/i tal-ġbid jillaxxa/w.

Eğer bu güvenlik aleti monte edilmemiş ise çocuk boğulabilir. Bu aleti her zaman kordonları ve zincirleri çocukların erişiminden uzak tutmak için kullanın.

Alet için tamir açıklamaları

Bu tutma aleti kontrol mekanizmasından mümkün olan en uzak mesafeye monte edilmelidir ki kıvrılan/dönen çekme kordonu (ları) boşalmasın.

Τα παιδιά μπορούν να πνιγούν αν αυτή η συσκευή ασφαλείας δεν εγκατασταθεί. Χρησιμοποιείτε πάντα αυτή τη συσκευή για να κρατά τα κορδόνια και τις αλυσίδες μακριά απο τα παιδιά.

Καθορισμός χρήσης της συσκευής.

Αυτή η συσκευή συγκράτησης πρέπει να εγκατασταθεί στη μέγιστη δυνατή απόσταση από τον μηχανισμό ελέγχου για την πρόληψη και αποφυγή των τυλιγμένων καλωδίων να καταστούν χαλαρά

www.silentgliss.co.uk

Silent Gliss Limited
Pyramid Business Park
Poorhole Lane
Broadstairs
Kent CT10 2PT

Telephone: 01843 863571
Fax: 01843 864503
info@silentgliss.co.uk