

Silent Gliss® 4960 Fitting Instructions

Ceiling Fix

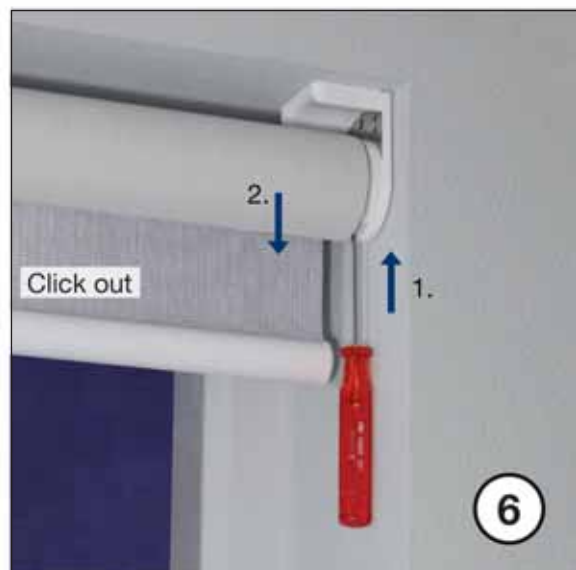
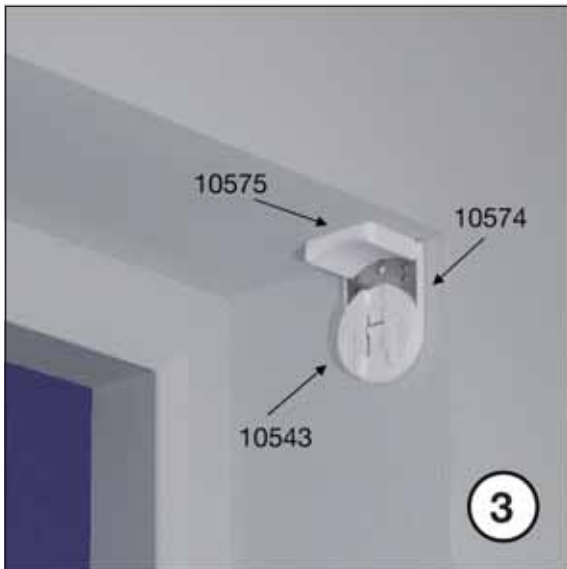
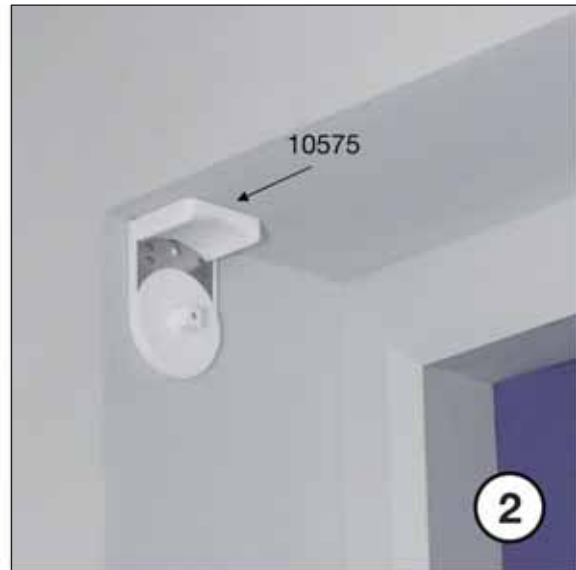
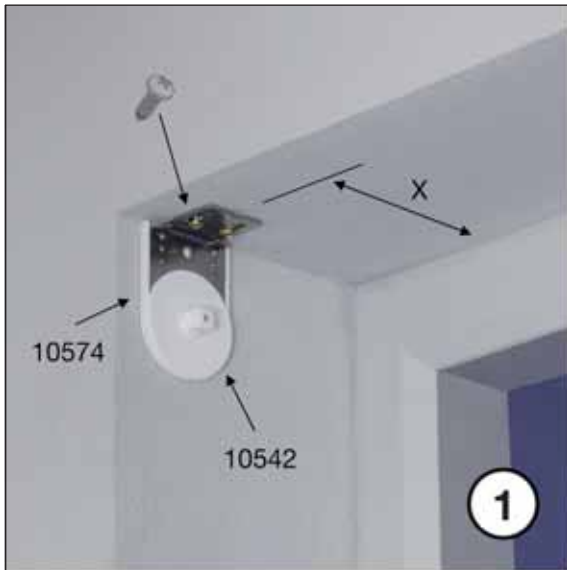

Silent Gliss® 4960 Fitting Instructions

Setting Limit Positions

Set Limit Positions using 0997 Setting lead

- Motors are delivered to SGGB in 'Programming' mode
- Motor limits are then set approximately during production (as normal)
- Limits can be reset on site either by 0997 test lead or by 9940 series wireless switches or handsets (wireless motors only)
- **A 0997 test lead will be required if non radio control type**
- Please note when adjusting or re-setting limits both the up and down limits must be reset - **individual limits cannot be set independently**

0997 Setting lead connections

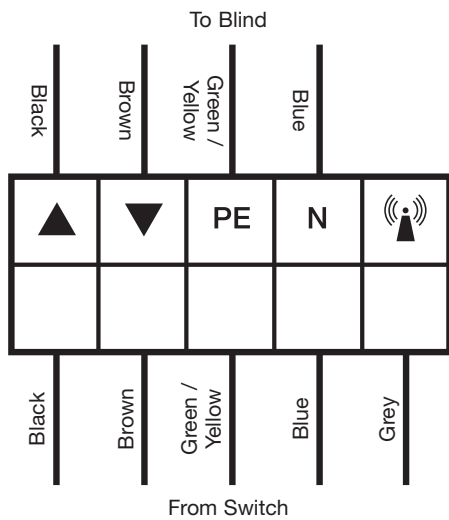

Connections for non integrated motor

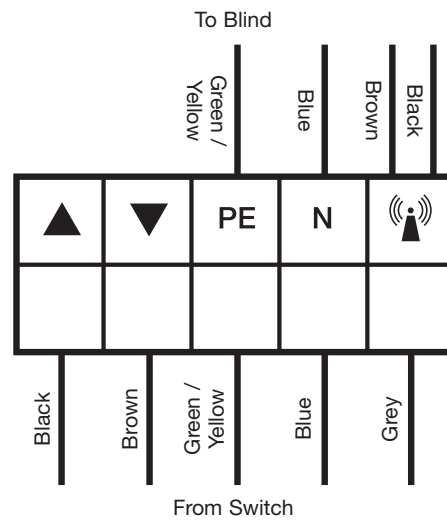

Connections for integrated motor

Changing/Erasing Limit Positions

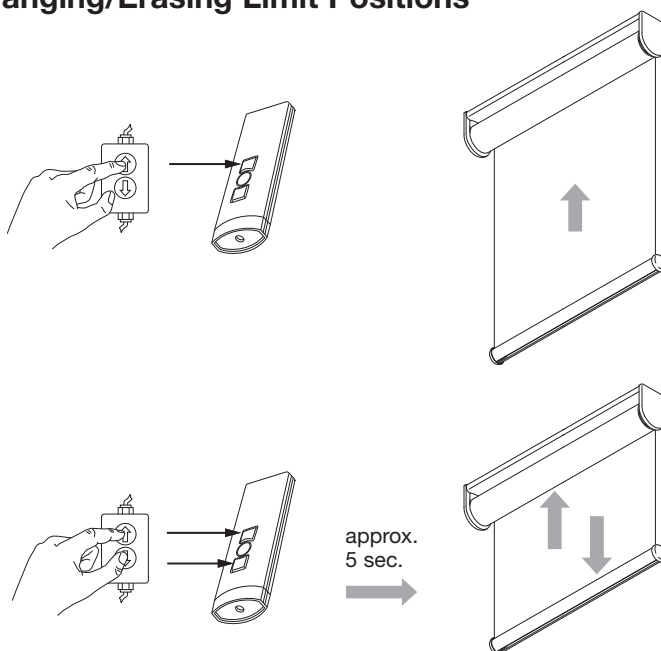

1. Drive blind to approximately mid position - thereby determining the direction of movement of the blind on the switch (you must allow at least 30cm of movement to the nearest limit setting position).
For integrated motors now unplug from the supply for 1 - 2 seconds and then re-connect.
2. Press the up and down buttons on the test lead (or handset) together, after approx. 5 sec. motor will respond with a short up and down movement.

⇒ **Limits are erased. Motor is now in limit setting mode**



Silent Gliss® 4960 Fitting Instructions

Setting Limit Positions

Setting Limit Positions - Limits can be set in either direction at this stage the instructions below start with the setting the down limit first.

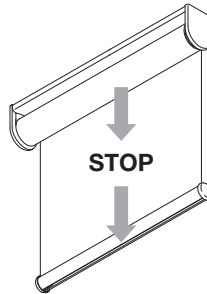
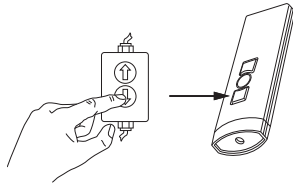

3. Hold the down button until motor 'jolts' and increases speed then continue pressing down button until blind is at required position.

(To get to an accurate limit position release the button and pulse in the same direction with the same button in small movements).

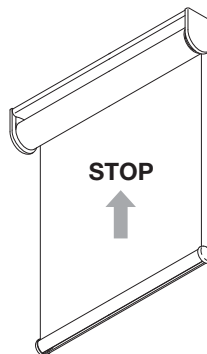
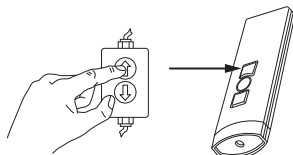

4. Press and hold the up button until motor stops automatically (approx 30 cm movement).

Release the up button

⇒ **Lower position is set**

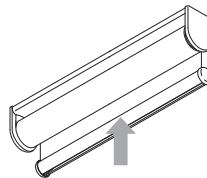
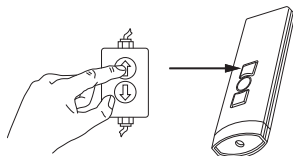

5. Hold the up button until motor 'jolts' and increases speed then continue pressing up button until blind is at required position.

(To get to an accurate limit position release the button and pulse in the same direction with the same button in small movements).

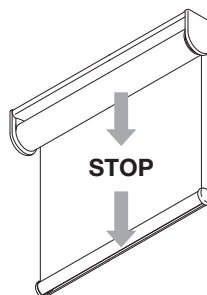
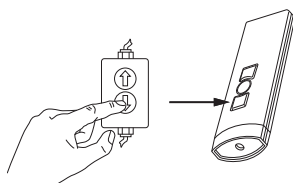

6. Press and hold the down button until motor stops automatically (approx 30 cm movement).

Release the down button.

⇒ **Both limits are set**



Silent Gliss® 4960 Fitting Instructions

Wall Fix

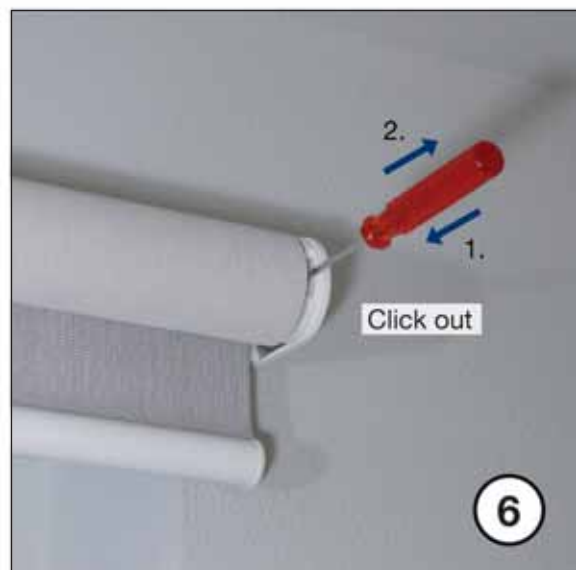
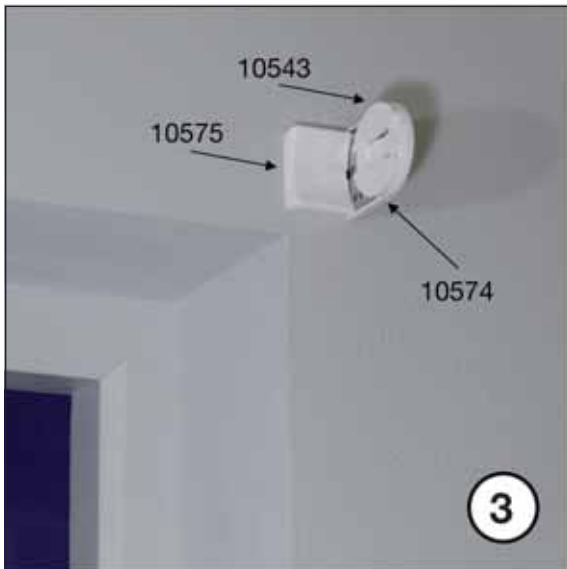
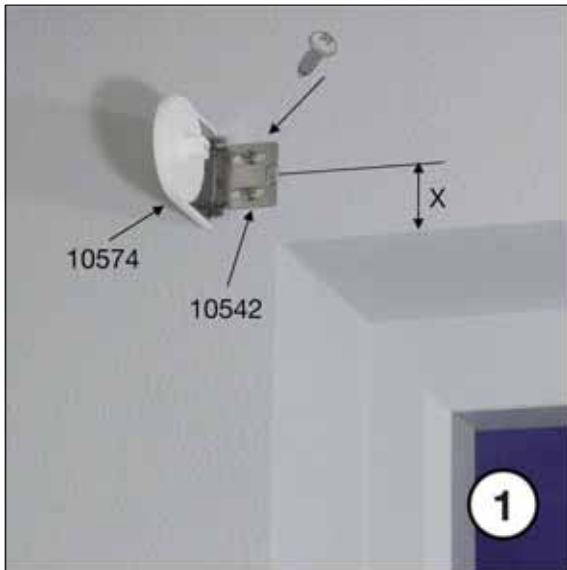

Silent Gliss® 4960 Fitting Instructions

Ceiling Fix Connected with installation profile (option)

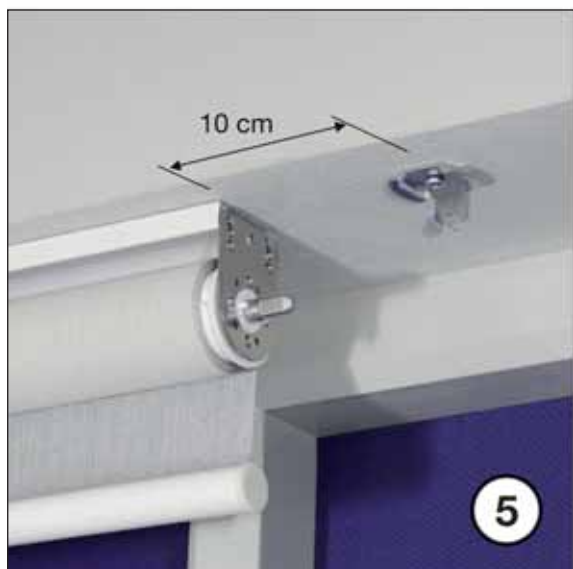
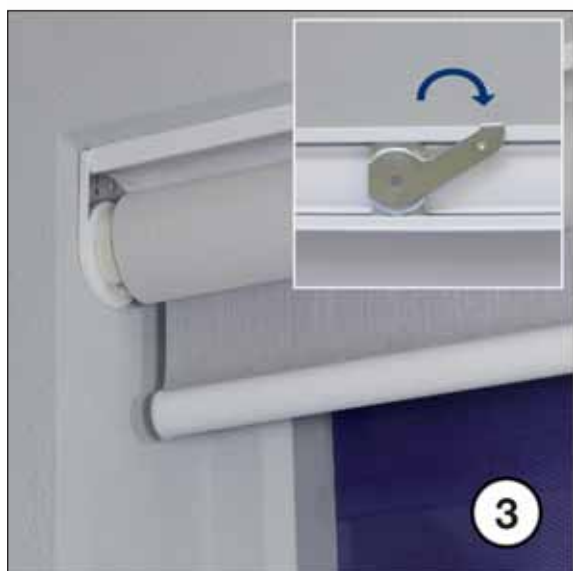
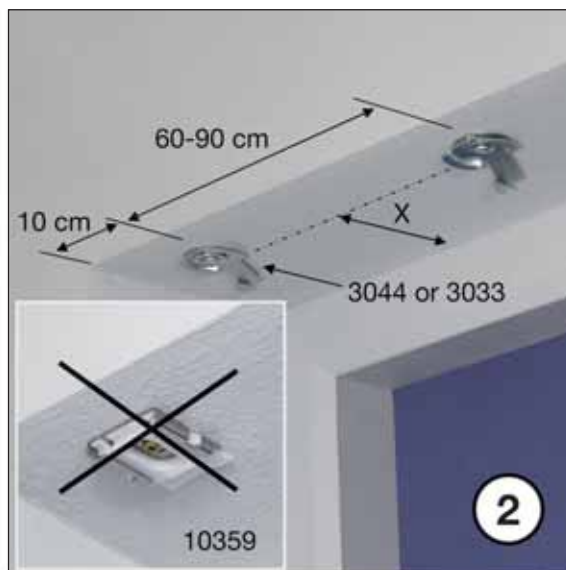
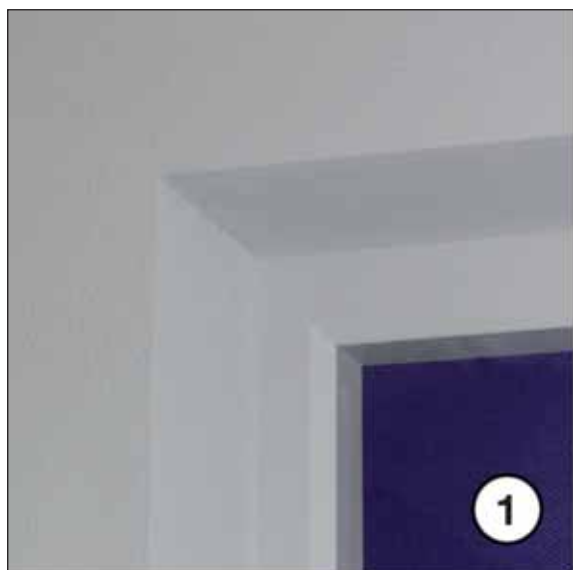

Silent Gliss® 4960 Fitting Instructions

Ceiling Fix Connected with installation profile (option)

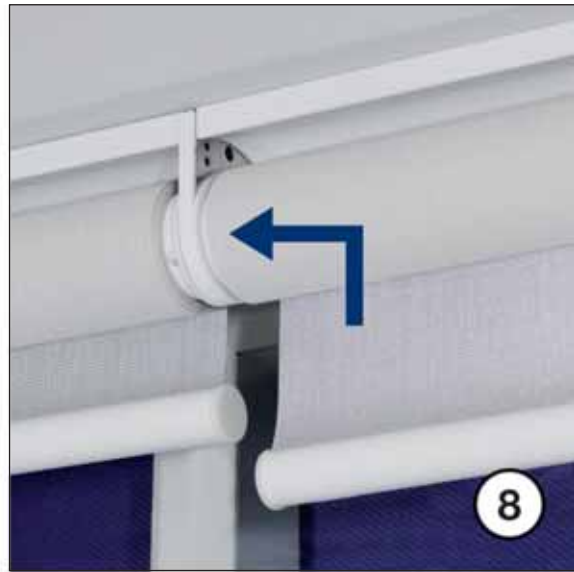

Silent Gliss® 4960 Fitting Instructions

Ceiling Fix Side guide (option)

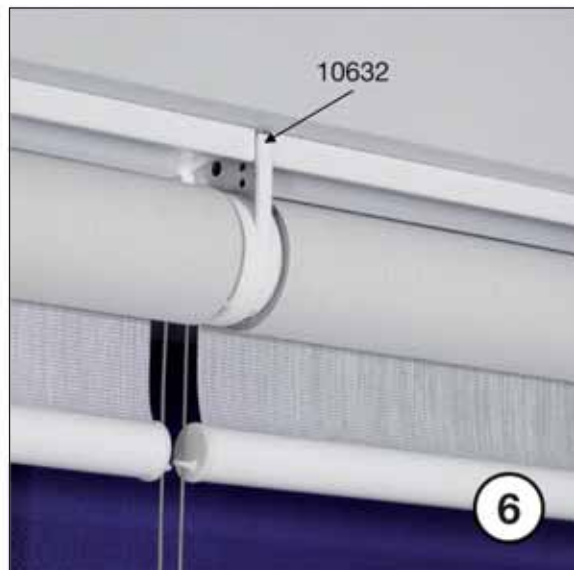
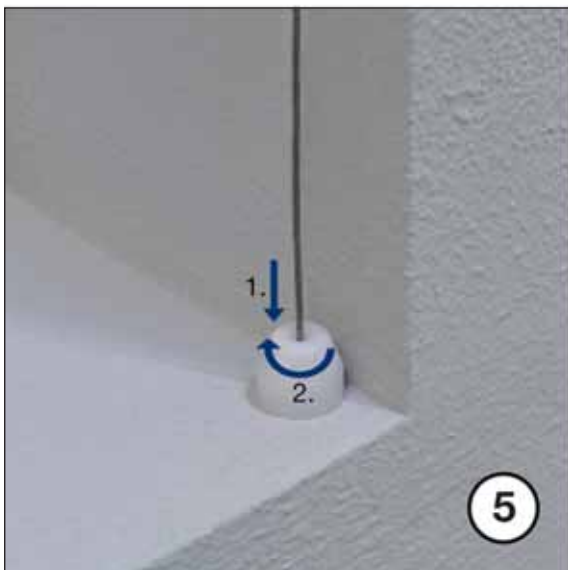
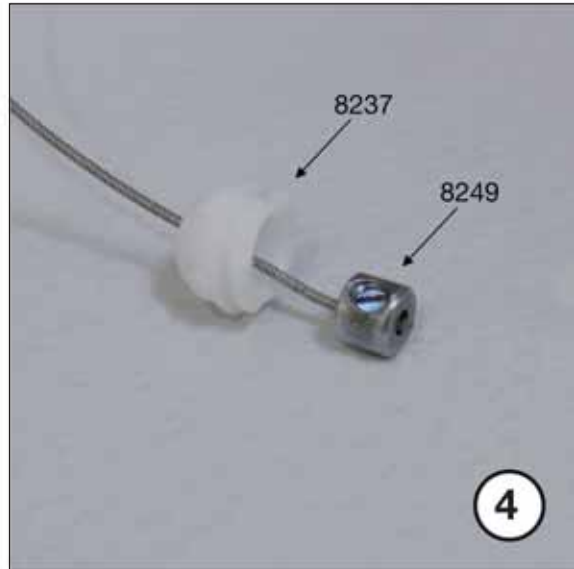
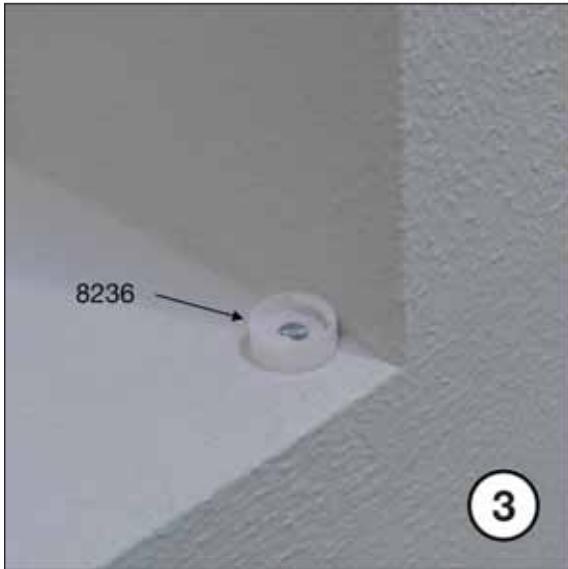

Silent Gliss® 4960 Fitting Instructions

Ceiling Fix Side guide (option)

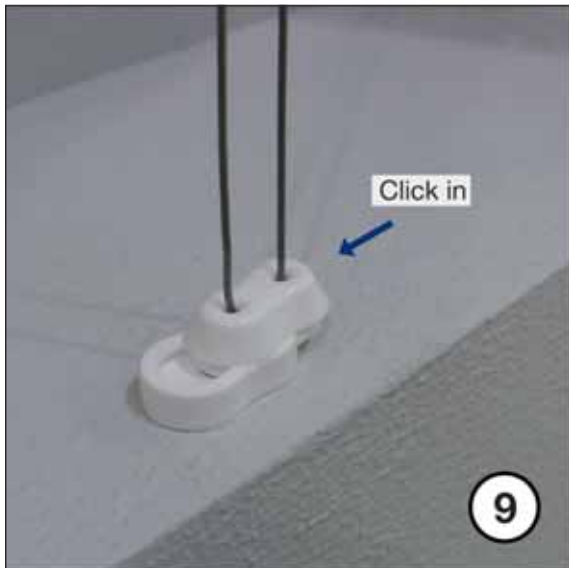
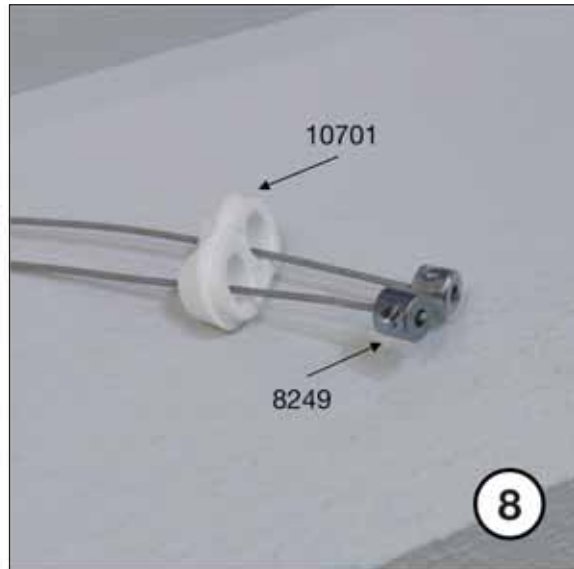
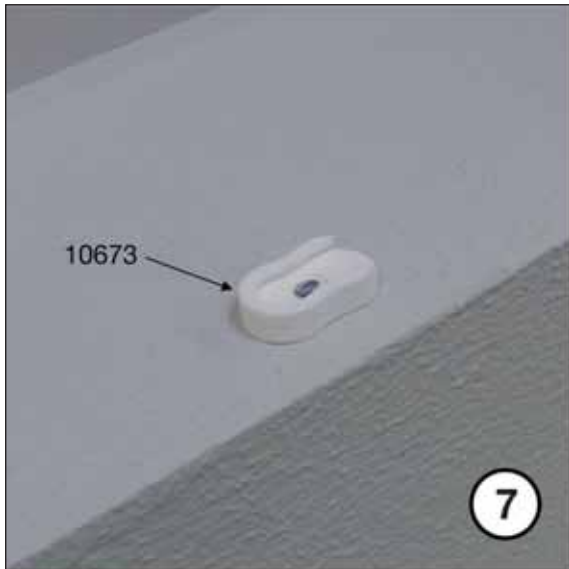

Silent Gliss® 4960 Fitting Instructions

Ceiling Fix Connected (option)

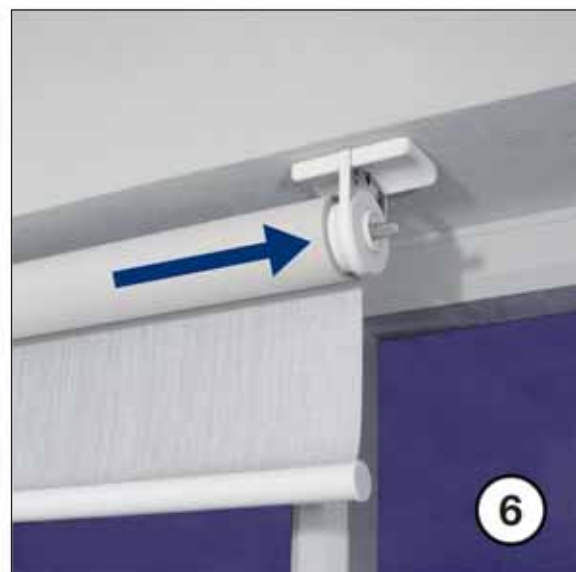
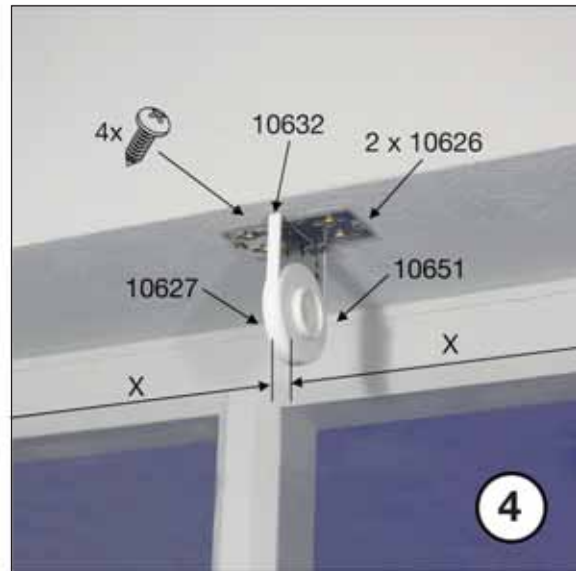
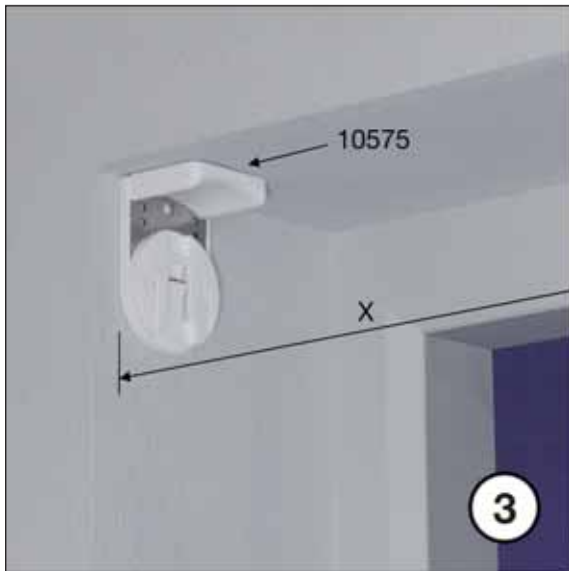
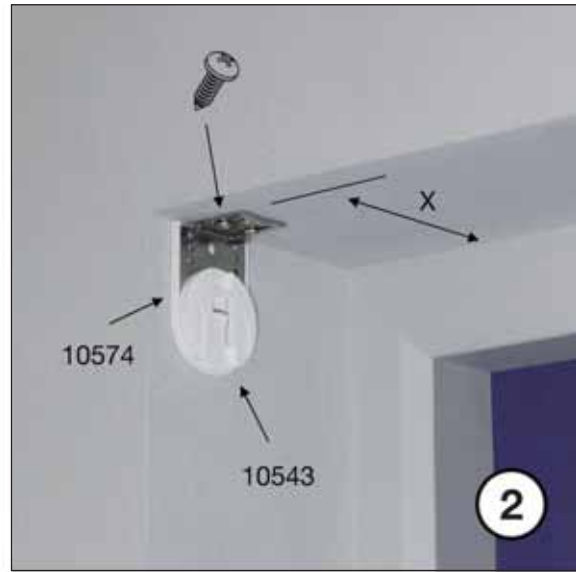
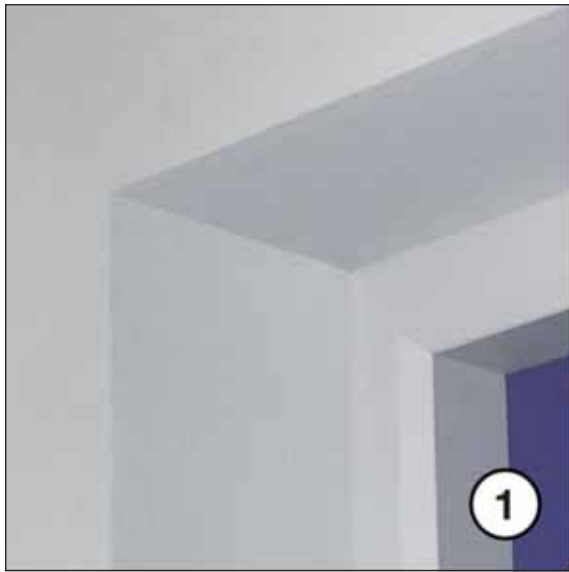

Silent Gliss® 4960 Fitting Instructions

Ceiling Fix Connected (option)

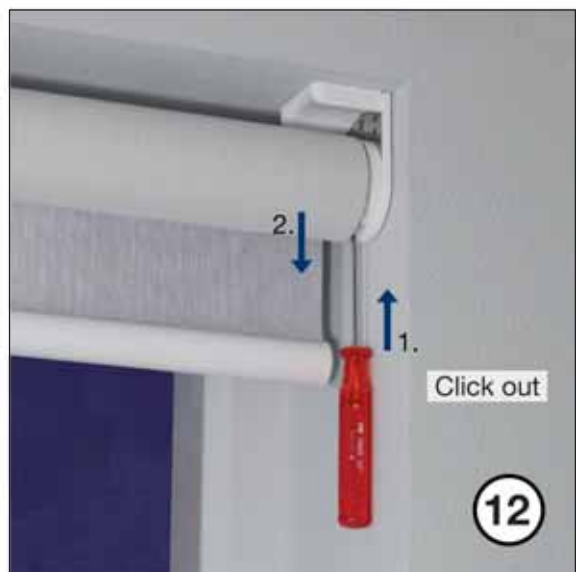
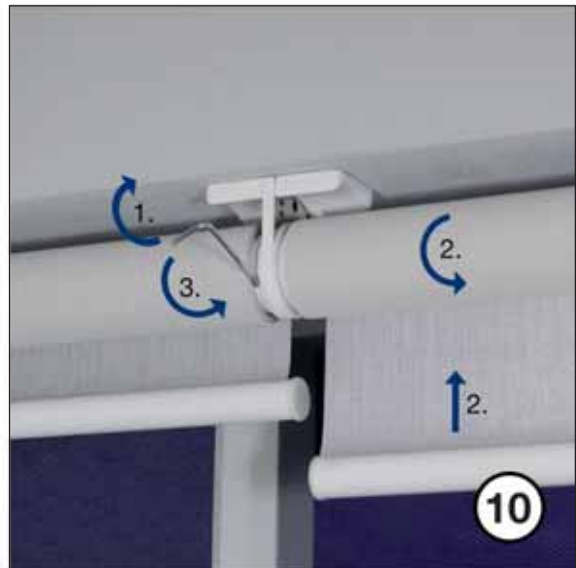
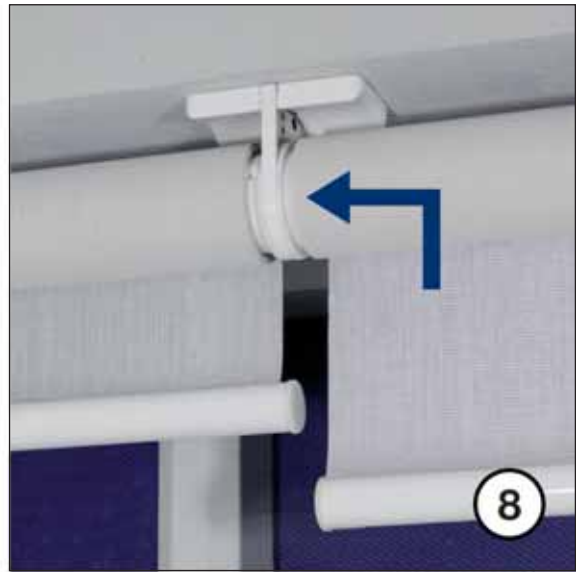
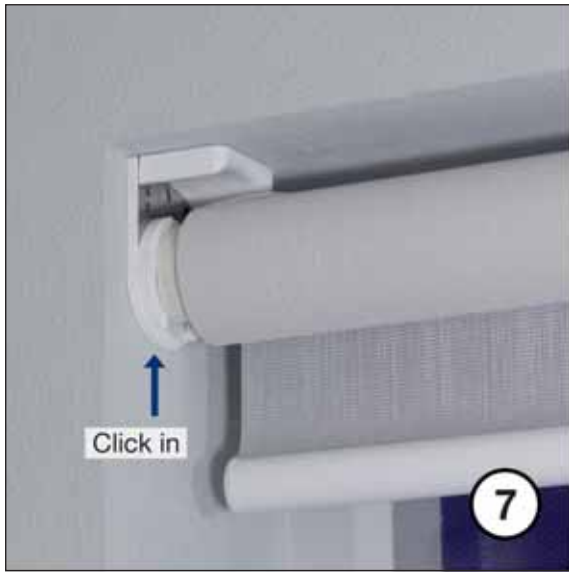

Silent Gliss® 4960 Fitting Instructions

Wall Fix Connected (option)

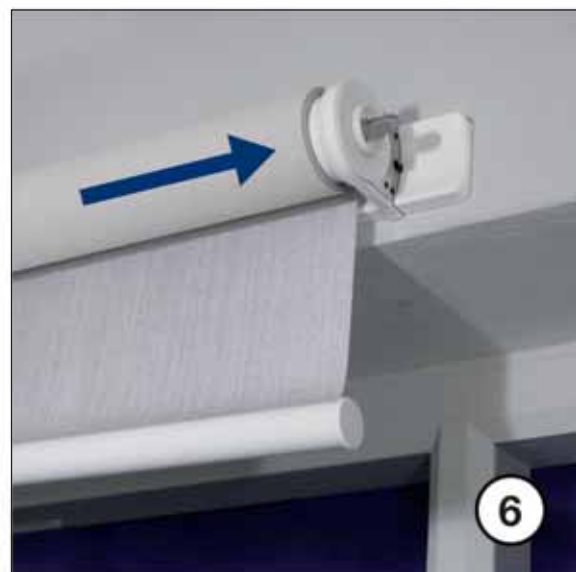
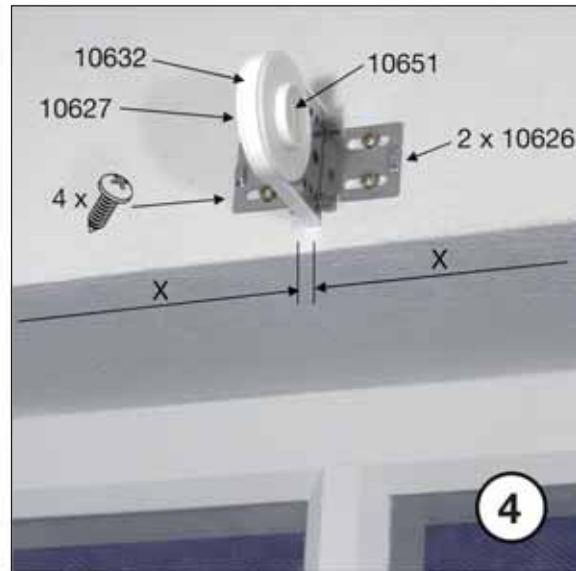
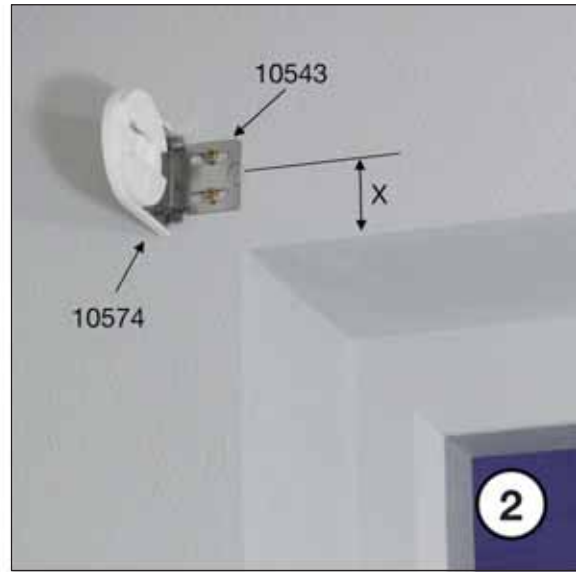
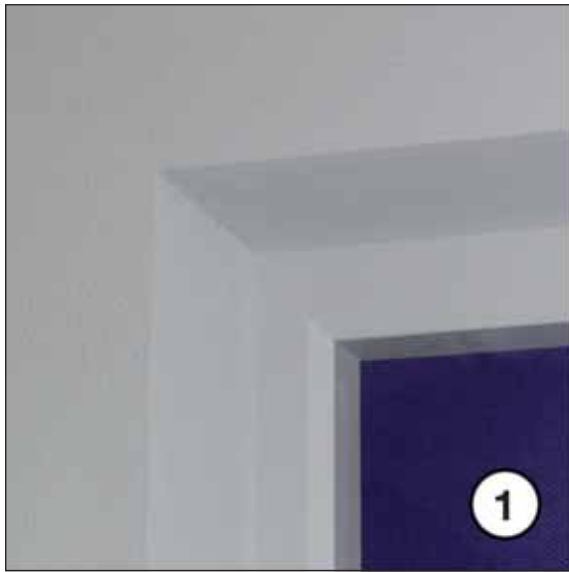

Silent Gliss® 4960 Fitting Instructions

Wall Fix Connected (option)

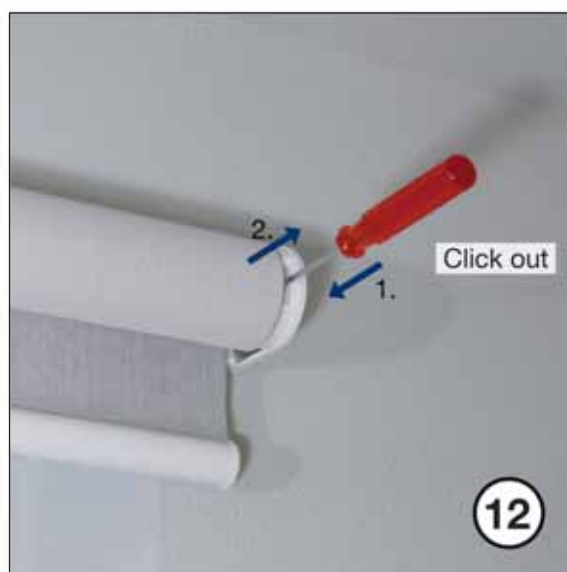
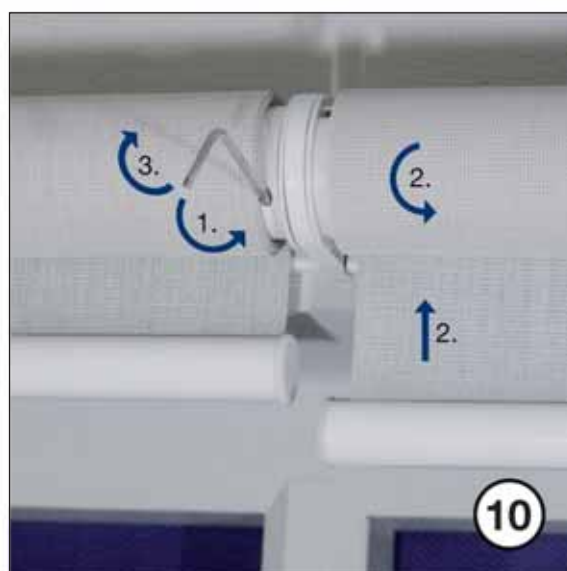
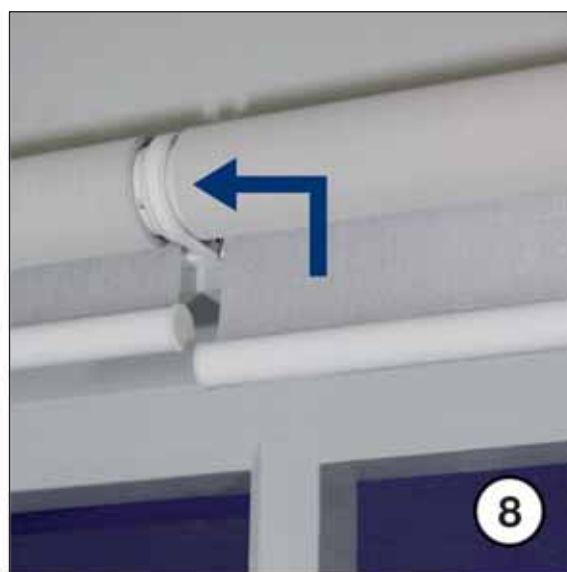

Silent Gliss® 4960 Fitting Instructions

Ceiling Fix with installation profile (option)

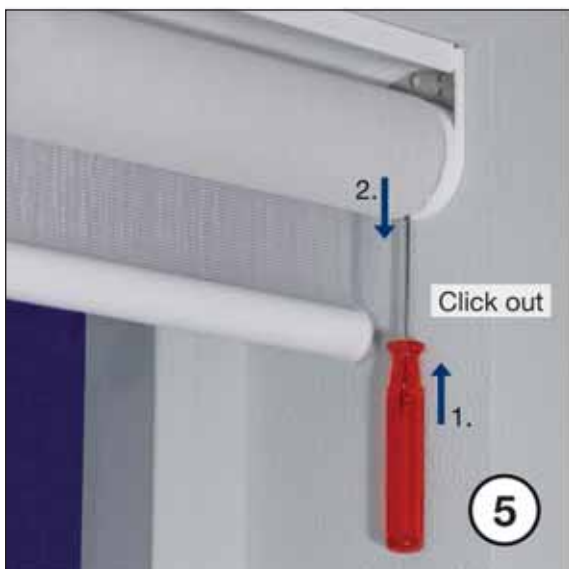
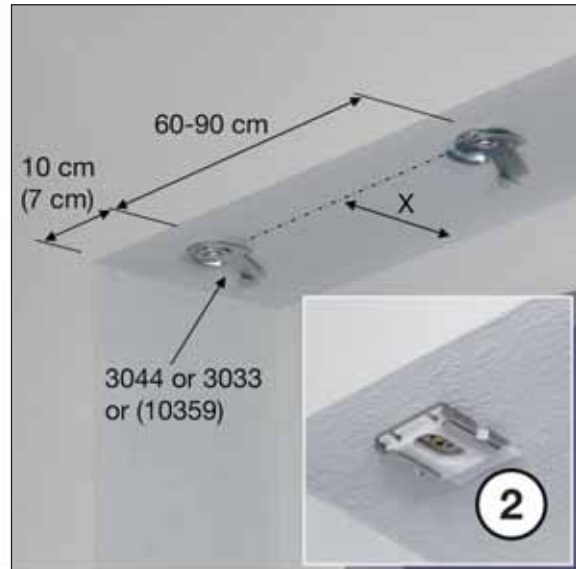
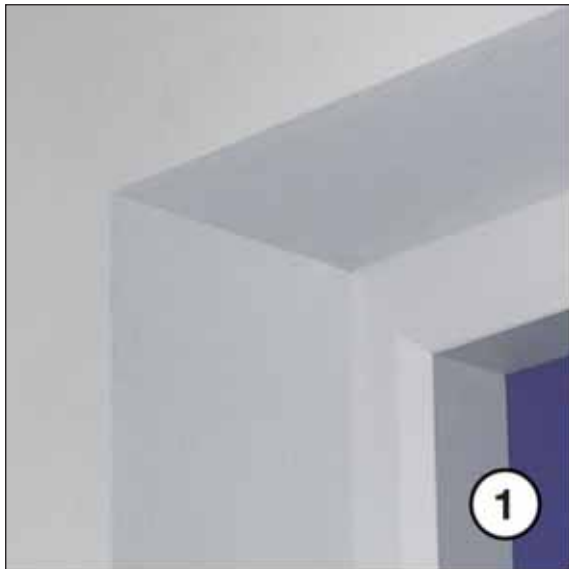

Silent Gliss® 4960 Fitting Instructions

Wall Fix With installation profile (option)

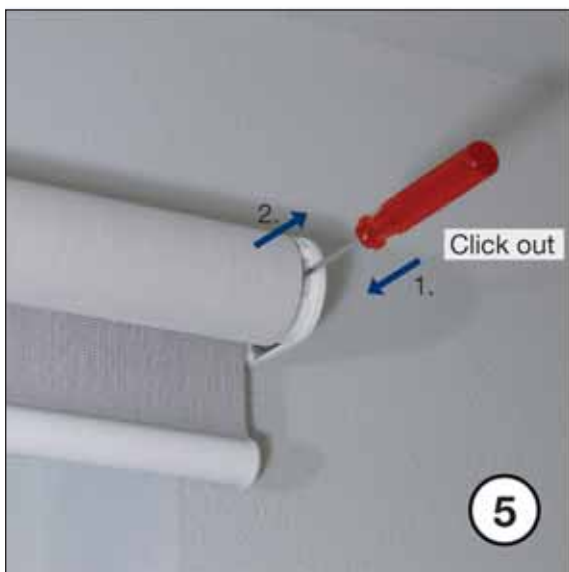
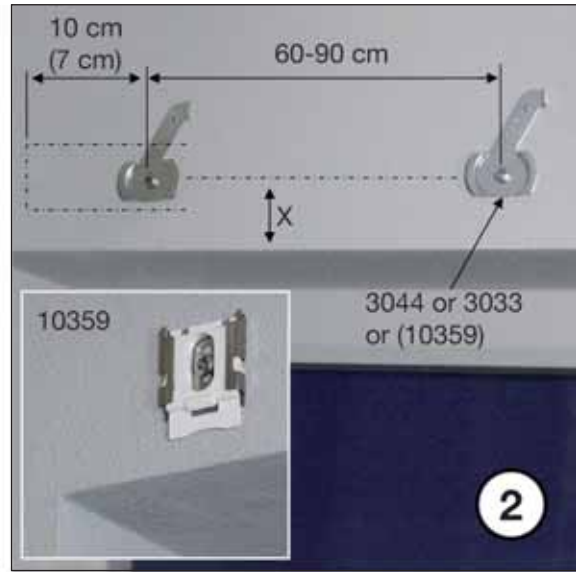
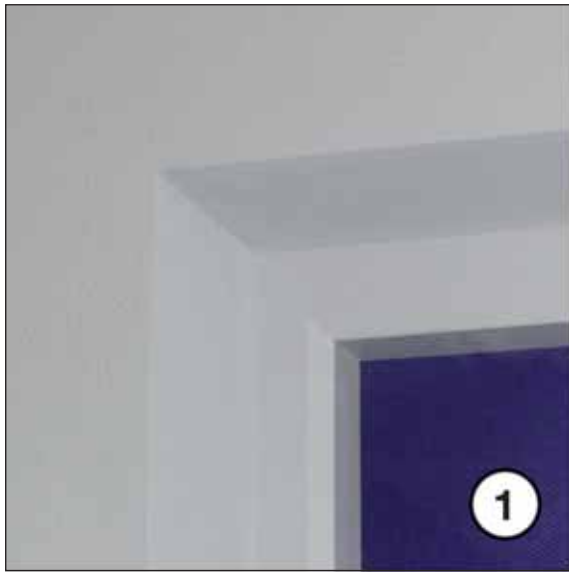

Silent Gliss® 4960 Fitting Instructions

Wall Fix Connected with installation profile (option)

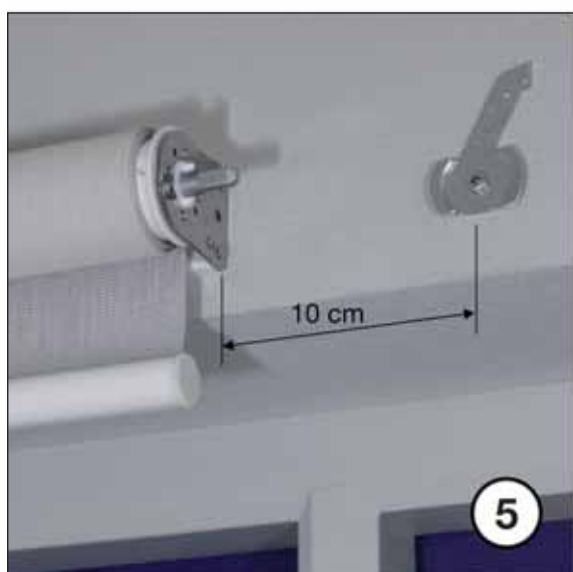
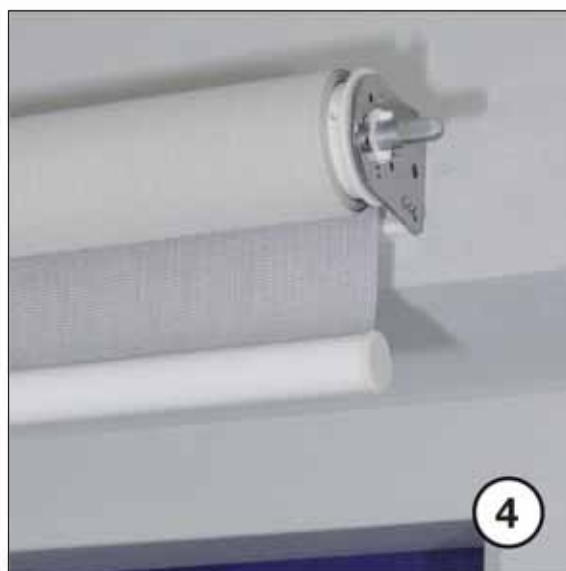
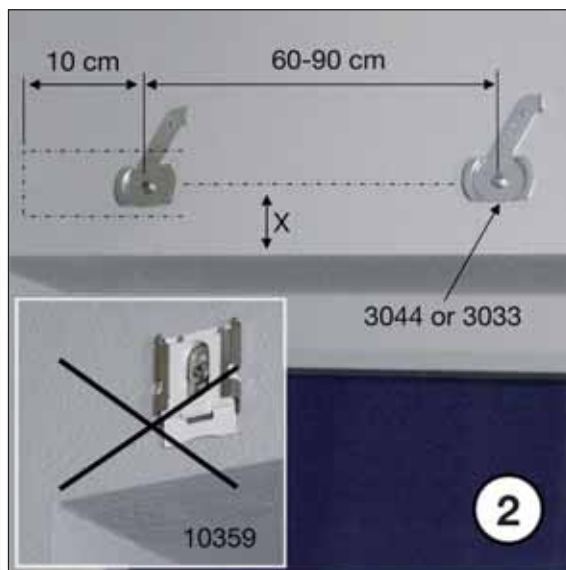
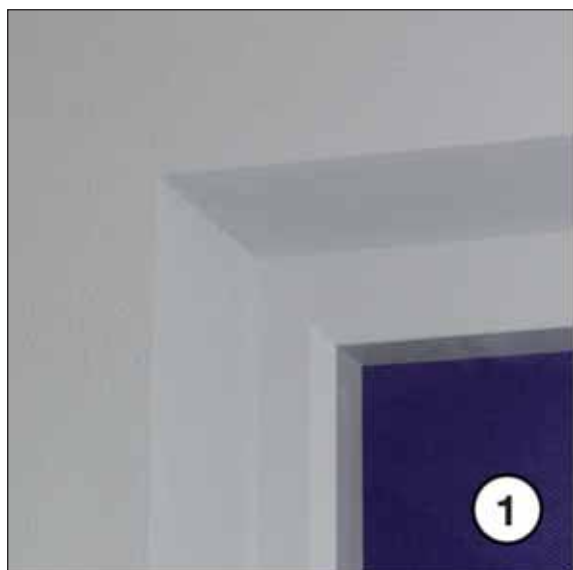

Silent Gliss® 4960 Fitting Instructions

Wall Fix Connected with installation profile (option)

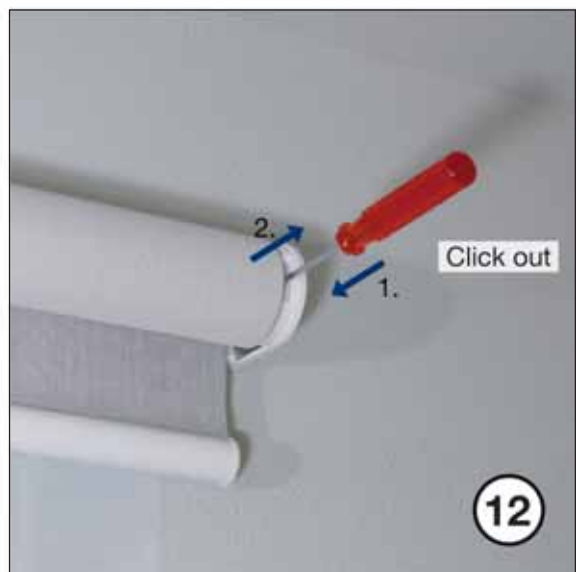
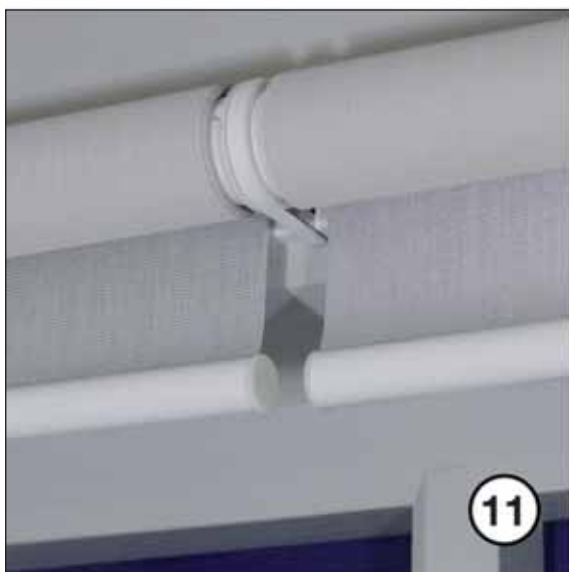
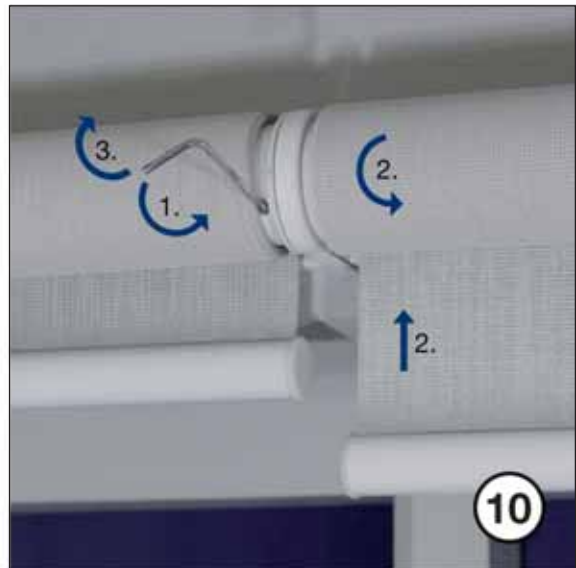
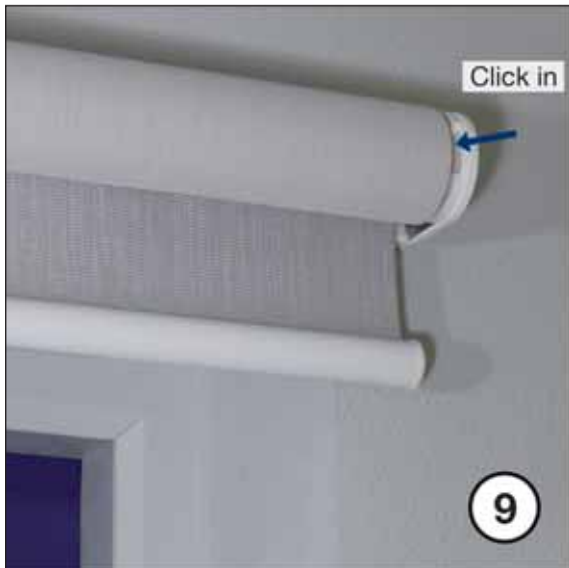
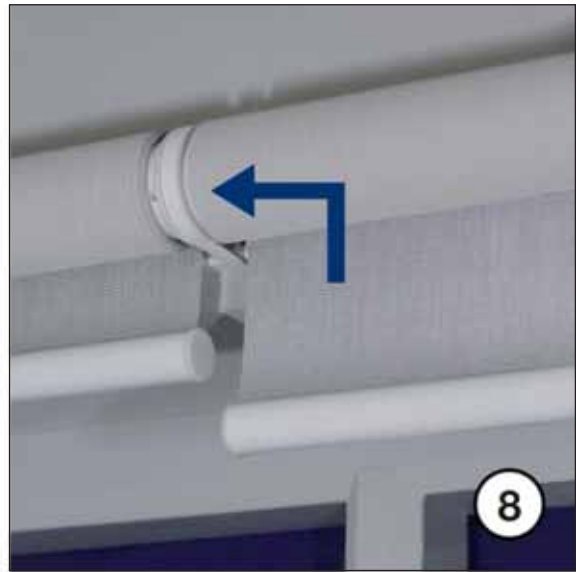

Silent Gliss® 4960 Fitting Instructions

Wall Fix Side guide (option)

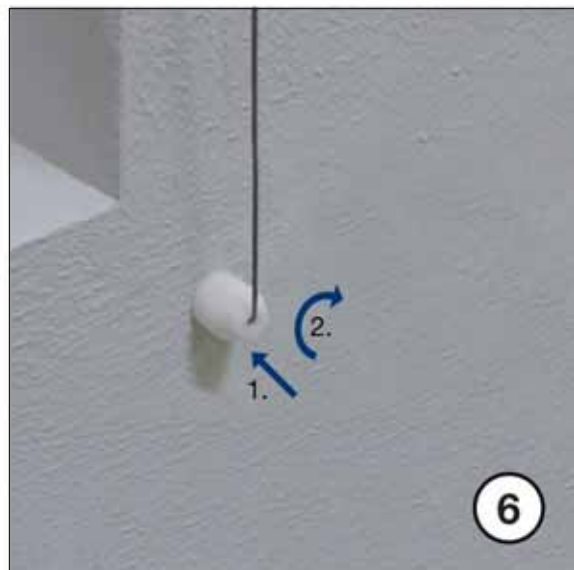
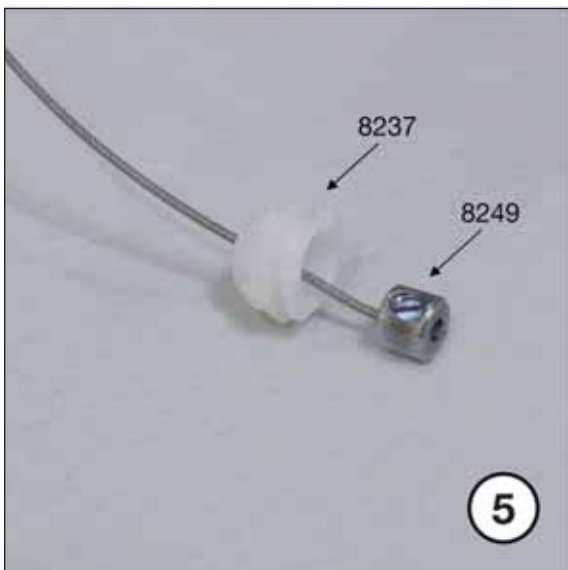
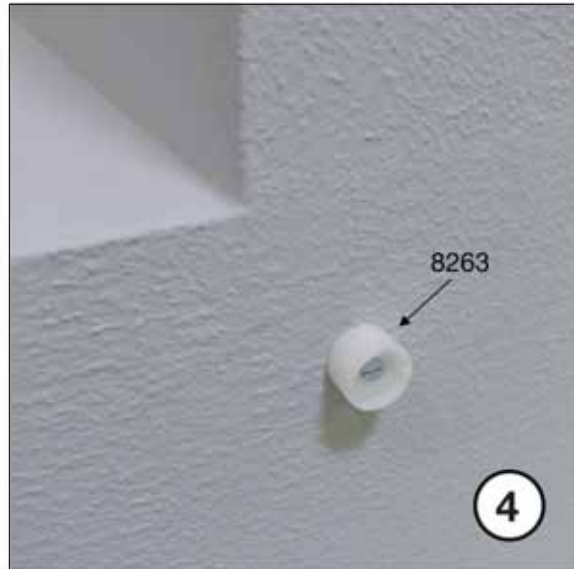
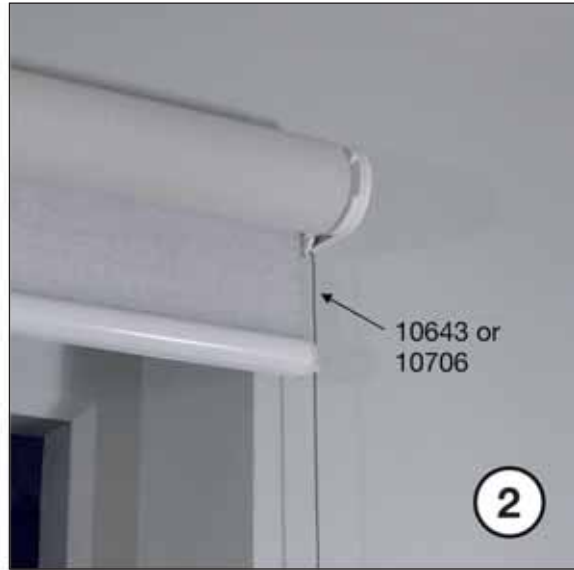
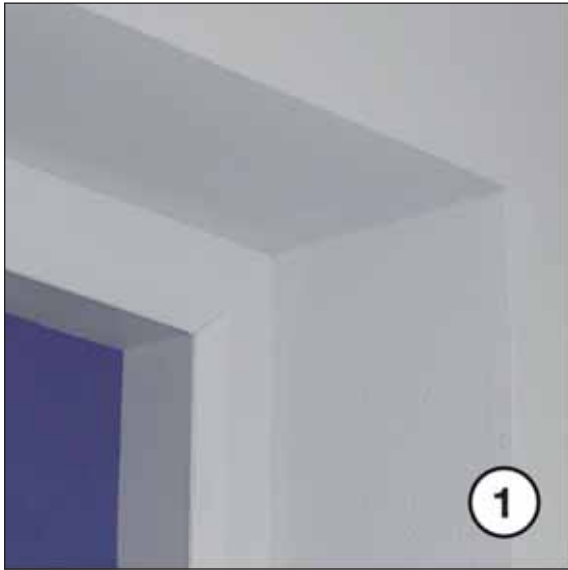

Silent Gliss® 4960 Fitting Instructions

Wall Fix Side guide (option)

