

Silent Gliss 4905

Fitting Instructions

Includes:

- **Ceiling Fix**
- **Wall Fix**

Ceiling Fix

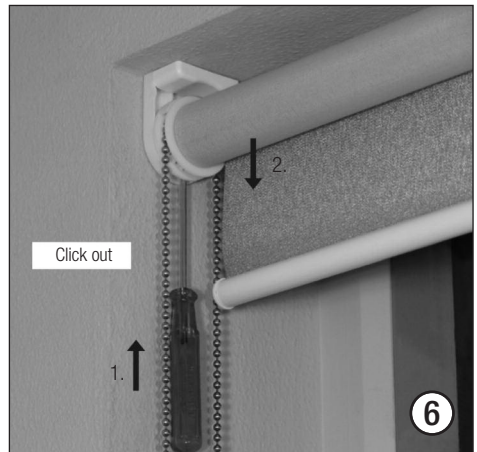
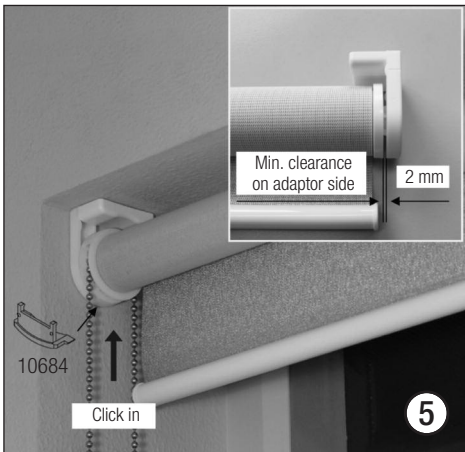
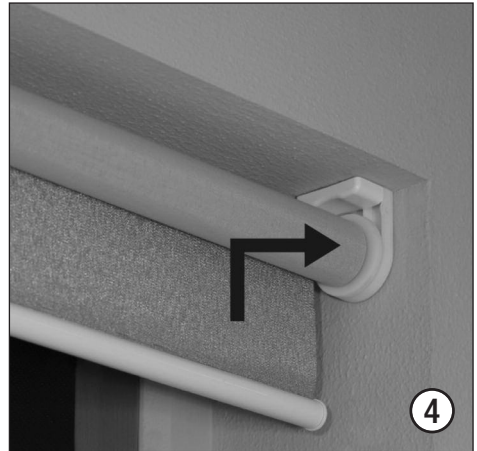
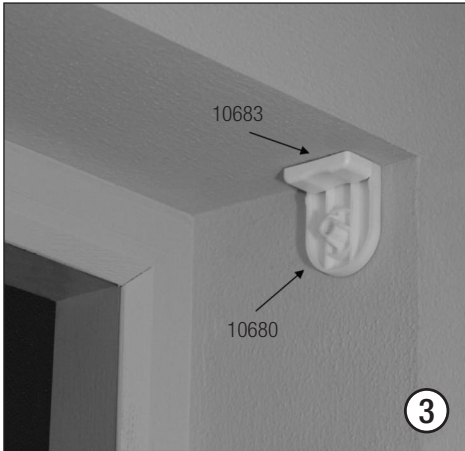
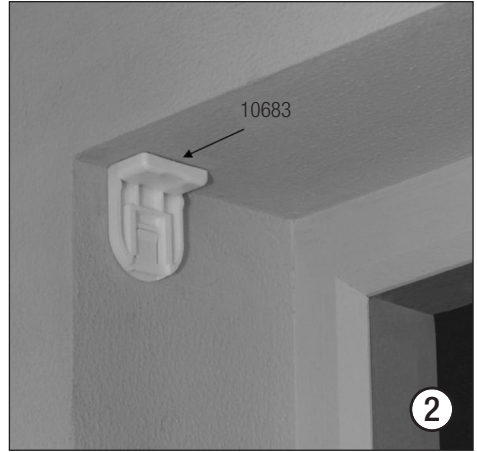
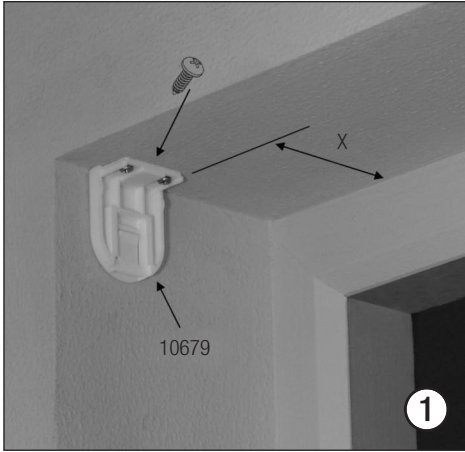

Wall Fix

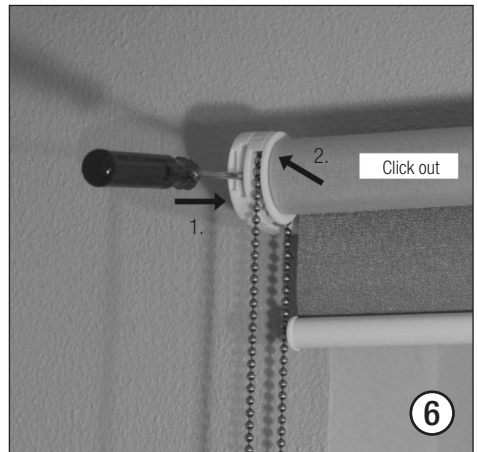
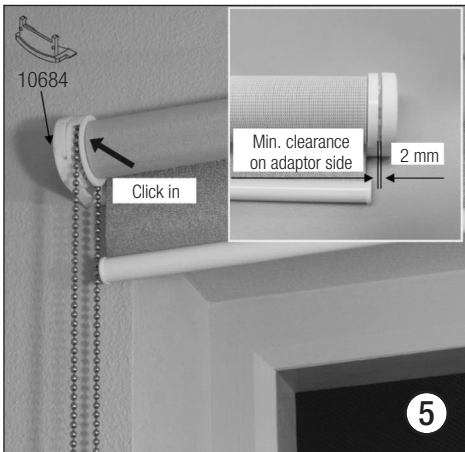
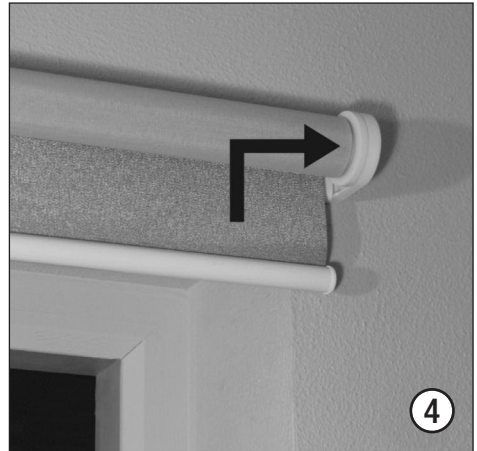
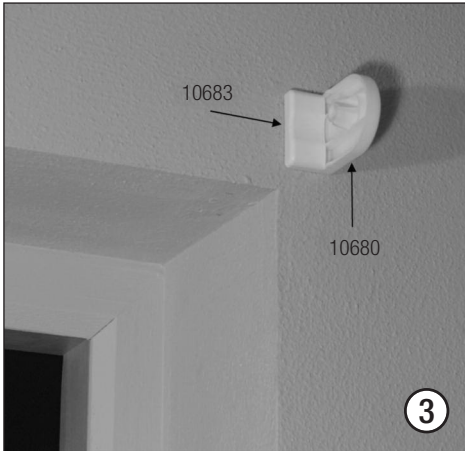
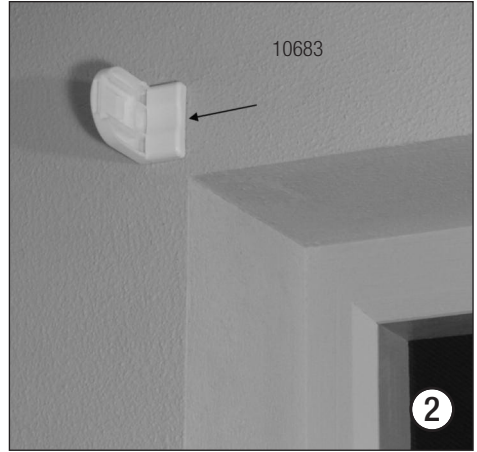
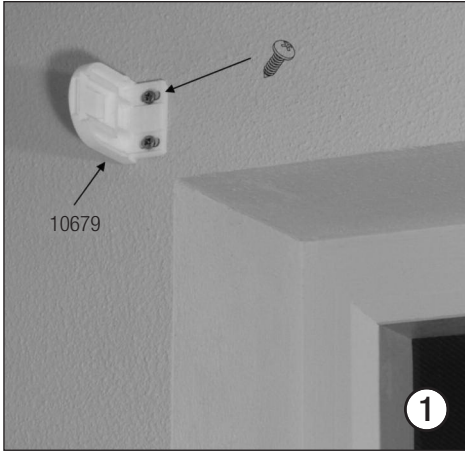

WARNING

Young children can be strangled by loops in pullcords, chains, tapes and inner cords that operate the product. To avoid strangulation and entanglement, keep cords out of the reach of young children. Cords may become wrapped around a child's neck. Move beds, cots and furniture away from window covering cords. Do not tie cords together. Make sure cords do not twist and create a loop.

TWISSIJA

It-tfal żgħar jistgħu jittgħallqu min'habba f'għoqod fil-kurduni tal-ġbid, fil-ktajjen, fit-tejps u fil-kurduni interni li jhaddmu l-prodott. Biex tevita tgħallieq u taħbil, zomm il-kurduni 'l bogħod mit-tfal. Hemm çans li l-kurduni jitgeżwru madwar għonq it-tfal. Ressaq kwalunkwe sodod, benniena u għamara 'l bogħod mill-kurduni tal-blajnds. Torbotx il-kurduni flimkien. Kun çert li l-kurduni ma jithabblux u joholqu għolqa.

UYARI

Küçük çocuklar, ürünü çalıştıran çekme kordonları, zincirler, bantlar ya da iç kısımlardaki iplerdeki döngüler nedeniyle boğulabilirler. Boğulma ve dolanmanın önlenmesi için kordonları küçük çocukların ulaşamayacağı yerlerde tutunuz. Kordonlar çocuğun boynuna sarılabılır. Yatakları, beşikleri/karyolaları ve eşyaları, pencereleri kaplayan kordonlardan uzağa taşıyın. Kordonları birbirine bağlamayın. Kordonların kıvrılıp döngü oluşturmadığından emin olun.

ΠΡΟΕΙΔΟΠΟΙΗΣΗ

Μικρά παιδιά μπορούν να στραγγαλιστούν από θηλιές σε κορδόνια έλξης, αλυσίδες, ταινίες και εσωτερικά κορδόνια με τα οποία λειτουργεί το προϊόν. Για την αποφυγή στραγγαλισμού και πνιγμού, τα κορδόνια πρέπει να βρίσκονται μακριά από μικρά παιδιά. Τα κορδόνια μπορεί να τυλιχθούν γύρω από το λαιμό του παιδιού. Μετακινήστε κρεβάτια, παιδικά κρεβάτια και έπιπλα μακριά από τα κορδόνια χειρισμού των κουρτινών.

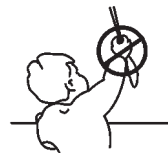

Silent Gliss Cord Retainer

Children can strangle if this safety device is not installed. Always use this device to keep cords and chains out of reach of children.

Fixing instruction for the device

This retaining device should be installed at the maximum distance possible from the control mechanism to prevent the looped pull cord(s) becoming slack.

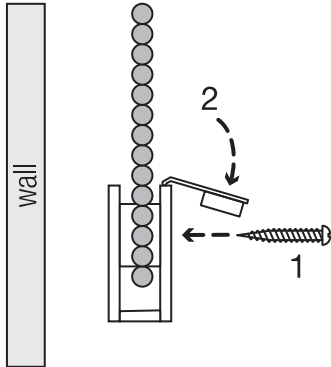

It-tfal jistghu jitghallqu jekk dan it-tagħmir ta' sigurtà ma jiġix installat. Dejjem uża dan ittagħmir biex iżzomm il-kurduni u l-ktajjen 'il bogħod mit-tfal.

Struzzjonijiet biex jitwāħhal it-tagħmir

Dan it-tagħmir tal-irbit għandu jiġi installat kemm jista' jkun 'il bogħod mill- mekkaniżmu ta' kontroll sabiex jiġi evitat li l-kurdun/i tal-għbid jillaxka/w.

Eğer bu güvenlik aleti monte edilmemiş ise çocuk boğulabilir. Bu aleti her zaman kordonları ve zincirleri çocukların erişiminden uzak tutmak için kullanın.

Alet için tamir açıklamaları

Bu tutma aleti kontrol mekanizmasından mümkün olan en uzak mesafeye monte edilmelidir ki kıvrılan/dönen çekme kordonu (ları) boşalmasın.

Silent Gliss Child Safety Device

An integral safety device available for use with corded Metropole systems supplied pre-assembled on the operating cord. Should an incident occur which causes the device to separate simply follow the instructions on the drawing to reassemble.

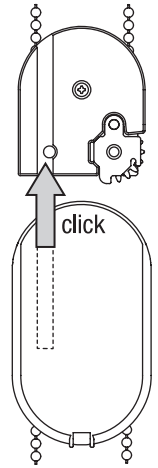

Τα παιδιά μπορούν να πνιγούν αν αυτή η συσκευή ασφαλείας δεν εγκατασταθεί. Χρησιμοποιείτε πάντα αυτή τη συσκευή για να κρατά τα κορδόνια και τις αλυσίδες μακριά από τα παιδιά.

Καθορισμός χρήσης της συσκευής.

Αυτή η συσκευή συγκράτησης πρέπει να εγκατασταθεί στη μέγιστη δυνατή απόσταση από τον μηχανισμό ελέγχου για την πρόληψη και αποφυγή των τυλιγμένων καλωδίων να καταστούν χαλαρά



Silent Gliss Limited

Pyramid Business Park, Poorhole Lane, Broadstairs, Kent CT10 2PT

Telephone: 01843 863571, Fax: 01843 864503, info@silentgliss.co.uk

www.silentgliss.co.uk

Silent Gliss Limited
Pyramid Business Park
Poorhole Lane
Broadstairs
Kent CT10 2PT

Telephone: 01843 863571
Fax: 01843 864503
info@silentgliss.co.uk