

# Silent Gliss®

## 1080 Hand Drawn Curtain Track Fitting Instructions

Congratulations on your purchase! Correctly fitted, your curtain track will give you many years of efficient use.

①

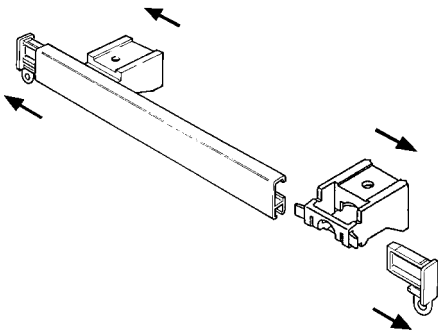

### Acetate packs

Remove end covers and slide out 2 brackets located at the ends of track. Replace end covers.

②

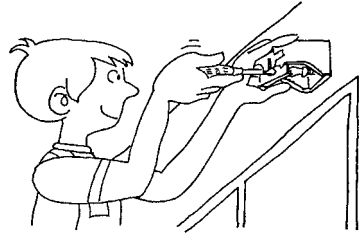

Firmly screw **3630** brackets to wall or ceiling. The two outside brackets should be located 4cm (2") in from the ends of track so as not to coincide with end covers. Remaining brackets should be equally spaced along track (approx. every 60cm/2').

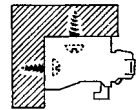

Screw for wall or ceiling with universal bracket.

③

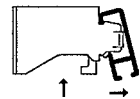
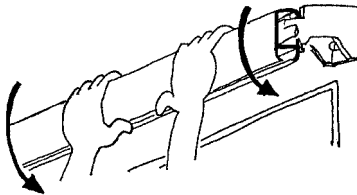
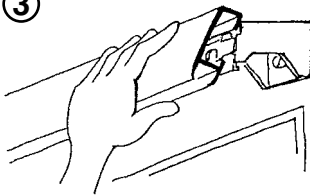

Removal push upwards and forwards.

To install track simply locate as shown and press onto bracket in direction indicated.

**P.T.O.** These instructions are continued on reverse side.

If you need to shorten the track...

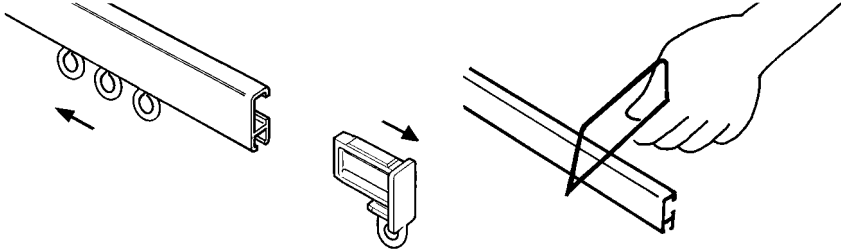

Remove end cover and slide gliders to other end.

Cut track squarely with junior hacksaw and deburr if necessary. Replace end cover.

## Extras/Accessories (not supplied)

A wide range of accessories is available for this most versatile curtain track. ask your dealer.

### Fixed extension brackets.

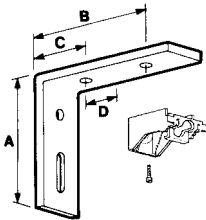

|             | A  | B     | C     |
|-------------|----|-------|-------|
| <b>3134</b> | 50 | 51.5  | -     |
| <b>3135</b> | 50 | 71.5  | 21.5  |
| <b>3136</b> | 50 | 91.5  | 41.5  |
| <b>3137</b> | 80 | 111.5 | 61.5  |
| <b>3138</b> | 80 | 141.5 | 91.5  |
| <b>3139</b> | 80 | 191.5 | 141.5 |
| <b>3239</b> | 70 | 150.0 | 130.0 |

(Dimensions in mm)

### Adjustable extension brackets.

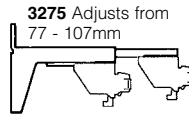

**3275** Adjusts from 77 - 107mm

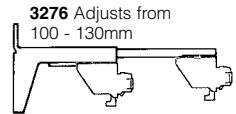

**3276** Adjusts from 100 - 130mm

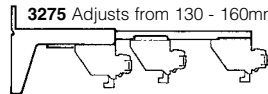

**3275** Adjusts from 130 - 160mm

Up to 3 tracks can be located on the same extension bracket or a pelmet formed around your existing track.

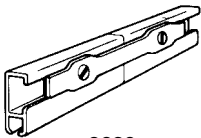

**3620**  
Connecting  
bridge

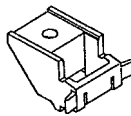

**3603**  
For ceiling fix  
or extension  
brackets.

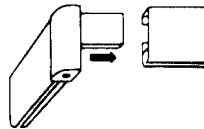

**3638**  
Corner piece  
for pelmet  
return.

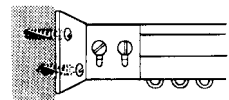

**3618**  
Wall support  
for pelmet  
return.

**1080** track is available in white, silver, black, gold, bronze, cream and beige to complement your decor. It can be bent to order for bay windows etc. from your stockist. **THIS TRACK CANNOT BE BENT AT HOME.**

### Silent Gliss Limited

Star Lane, Margate, Kent CT9 4EF, England  
Telephone: 01843 863571 Fax: 01843 864503  
E-mail: info@silentgliss.co.uk www.silentgliss.co.uk

