

Hand Operated Curtain Track Systems

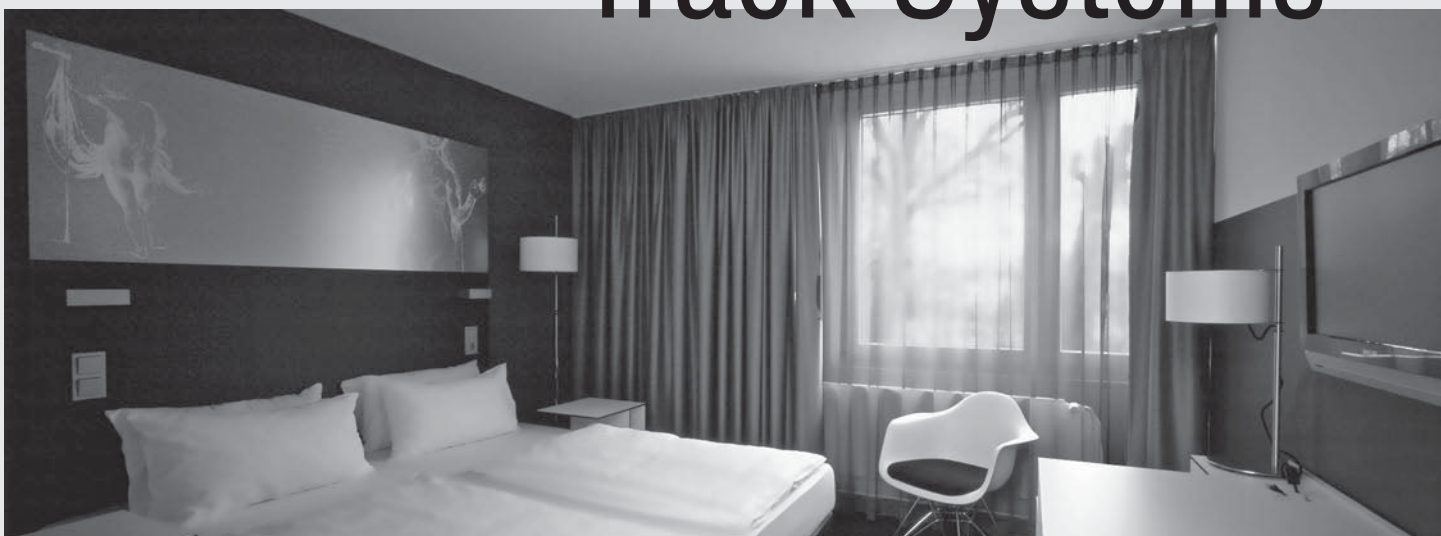

m





Hand Operated Curtain Track System

Silent Gliss® 1280

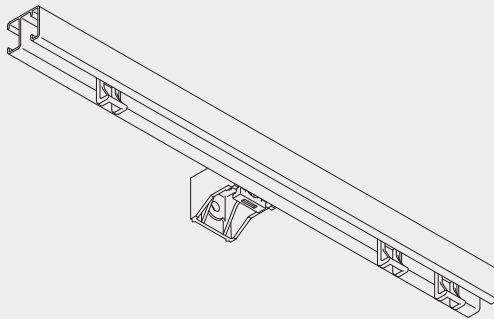

Product Information

- Versatile hand operated curtain track system for contract and domestic applications
- For medium to heavy weight curtains
- Patented roller gliders glide on rim of front channel with very little friction for smooth and easy operation
- Standard profile colour: white
- Easy wall or ceiling fixing
- Available in 4m, 5m and 6m lengths
- Can be bent



1280

Profile, Bending and Specification Information

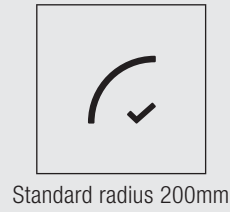
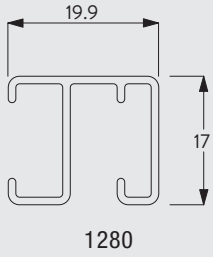

The standard radius is recommended for optimal operation. The minimum possible radius is 150mm.

Specification Guide- download from www.silentgliss.co.uk (password required).

Silent Gliss 1280 hand drawn curtain track in white powder-coated aluminium. Use roller gliders 3922 at 10/m, fix to wall with brackets 3630/3660, ceiling with brackets 3603 every 300mm. Fit endcovers 3985.

Fitting Information

Bracket positioning and fixing with universal brackets 3603, 3630, 3655, 3660



The fixing distances are meant as a guide only: they may vary in practice depending on the surface and curtain weight.

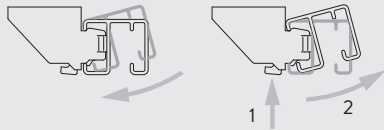

Installation: Roll track onto bracket in direction indicated
Removal: 1. Press to release 2. Rotate forward for removal

Quick-clip glider 3933

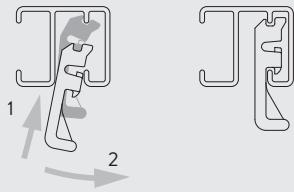

System 1280 is supplied with 3922 roller glider as standard, quick-clip glider 3933 is available as an optional accessory.

Fitting Options

Ceiling fix with bracket 3603

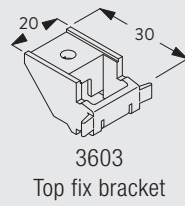
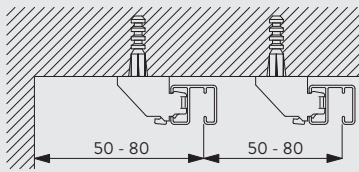

The final distances may be outside of the recommendations above depending on curtain heading, make-up and any obstructions.

Wall fix with universal brackets 3630/3655/3660

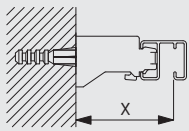

| | X (mm) |
|------|--------|
| 3630 | 42 |
| 3655 | 57 |
| 3660 | 72 |

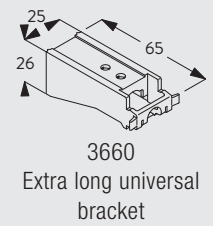
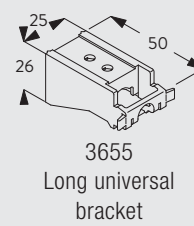
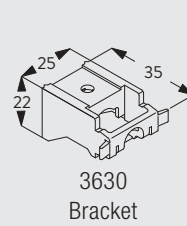

Wall fitting with Smart Fix 11200-11204 and bracket 3603

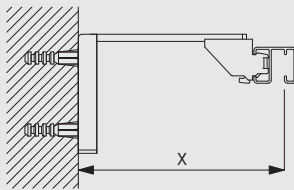

| | X (mm) |
|-------|--------|
| 11200 | 80 |
| 11201 | 100 |
| 11202 | 120 |
| 11203 | 140 |
| 11204 | 170 |

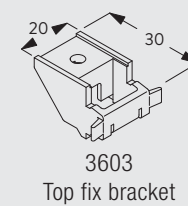
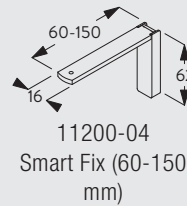

Brackets feature thread for screw M4x8 for fixing bracket SG 3603.

Wall fitting with Square Smart Fix 11210-11214 and bracket 3603

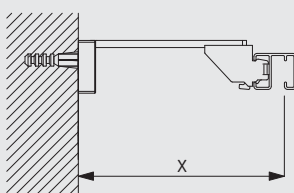

| | X (mm) |
|-------|--------|
| 11210 | 80 |
| 11211 | 100 |
| 11212 | 120 |
| 11213 | 140 |
| 11214 | 170 |

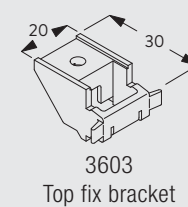
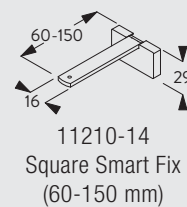

Brackets feature thread for screw M4x8 for fixing bracket SG 3603.

Wall fitting with Universal Smart Fix 11154-11156 and bracket 3603

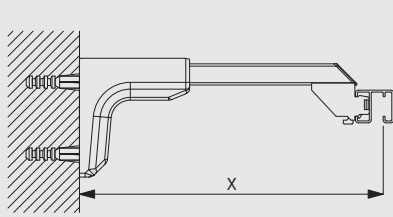

| | X (mm) |
|-------|---------|
| 11154 | 130-158 |
| 11155 | 160-188 |
| 11156 | 210-238 |

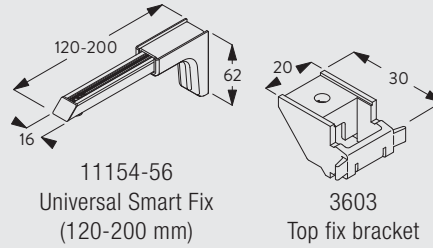





Brackets feature thread for screw M4x12 for fixing bracket SG 3603.

Standard Accessories

| | | | | | |
|------|-----------------------------|--|------|---------------------------|--|
| 18R | Screw 25mm. No. 8 roundhead | | 1280 | Profile | |
| 3630 | Bracket | | 3922 | Roller 3911 in strip form | |
| 3985 | Endcover | | | | |

Optional Accessories

| | | | | | |
|-------|---------------------------------|--|-------|---------------------------------|--|
| 3603 | Top fix bracket | | 3620 | Connecting bridge | |
| 3660 | Extra long universal bracket | | 3932 | Spring stop | |
| 3933 | Glider 3933 in strip form | | 3942 | Endstop | |
| 3975 | Overlap arm for pulling by hand | | 10430 | Draw rod with hook, 50cm | |
| 10431 | Draw rod with hook, 75cm | | 10432 | Draw rod with hook, 100cm | |
| 10433 | Draw rod with hook, 125cm | | 10434 | Draw rod with hook, 150cm | |
| 11154 | Universal Smart Fix, 120 mm set | | 11155 | Universal Smart Fix, 150 mm set | |
| 11156 | Universal Smart Fix, 200 mm set | | 11200 | Smart Fix, 60 mm set | |
| 11201 | Smart Fix, 80 mm set | | 11202 | Smart Fix, 100 mm set | |

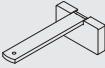
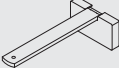
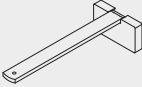
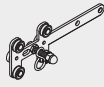
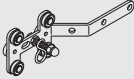
| | | | | | |
|-------|------------------------------|---|-------|---------------------------------------|---|
| 11203 | Smart Fix, 120 mm set |  | 11204 | Smart Fix, 150 mm set |  |
| 11210 | Square Smart Fix, 60 mm set |  | 11211 | Square Smart Fix, 80 mm set |  |
| 11212 | Square Smart Fix, 100 mm set |  | 11213 | Square Smart Fix, 120 mm set |  |
| 11214 | Square Smart Fix, 150 mm set |  | 3935A | Overlap arm straight with S-hook 3949 |  |
| 3936A | Overlap arm with s-hook 3949 |  | | | |

Useful Information and Sewing Accessories

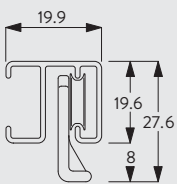





Diagram uses standard 3922 glider and is measured to the inside of the glider eye. For optional gliders substitute dimensions below:
 3945/3946 = 8mm
 3933 = 8mm

| | | | | | |
|------|---------------|---|------|------|---|
| 3562 | Standard tape |  | 3582 | Hook |  |
| 3599 | Hook |  | | | |



1280

Useful Measurements

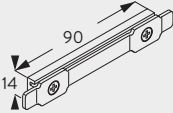
| | | |
|------|-------------------|---|
| 3620 | Connecting bridge |  |
|------|-------------------|---|

www.silentgliss.co.uk
www.silentglissglobal.com

Silent Gliss Ltd
Pyramid Business Park
Poorhole Lane
Broadstairs
Kent
CT10 2PT
Great Britain

Tel: +44 (0) 1843 863571
Fax: +44 (0) 1843 864503
info@silentgliss.co.uk

Silent Gliss Global Ltd
Pyramid Business Park
Poorhole Lane
Broadstairs
Kent
CT10 2PT
Great Britain

Tel: +44 (0) 1843 874250
Fax: +44 (0) 1843 874457
info@silentglissglobal.com