

# Hand Operated Curtain Track Systems





## Hand Operated Curtain Track System

# Silent Gliss® 6010

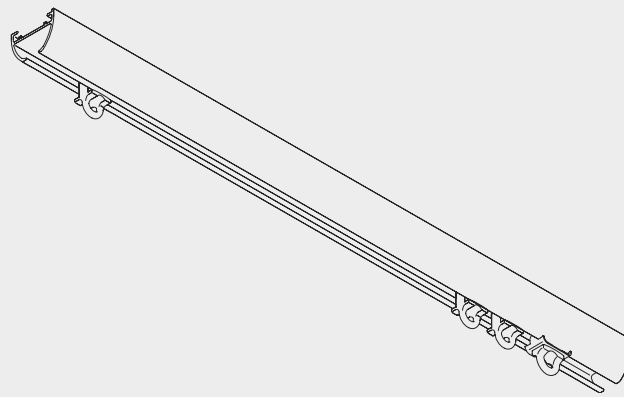

### Product Information

- Hand operated curtain track for medium weight curtains in domestic and contract applications.
- Very elegant, bendable profile (Min. radius 15cm) with hidden fixing channel.
- Easy fixing with hidden clamp to all kind of ceilings.
- Supplied white powder coated as standard.
- Standard length of the profiles are 6m.
- Systems can be planned to unlimited lengths due to a special connecting bridge.
- Available with Wave curtain heading system.



6010

## Profile and Bending Information

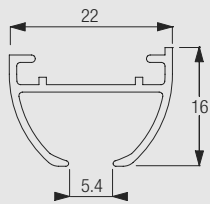

6010

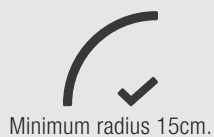

Minimum radius 15cm.

## How to measure

### Stack depth Wave Standard

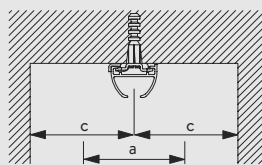
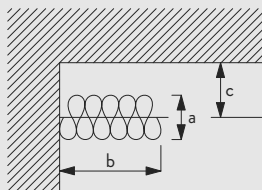

a = Stack depth  
b = Stack size  
c = Min. distance

Glider-cord spacing	Curtain hook spacing	Approx. curtain fullness	Stack depth (a)	Stack width (b)	Min distance (c)
6	10	2.1	10	23 per metre of track + endpiece	8
6	12	2.3	12	23 per metre of track + endpiece	9
8	14	2.1	14	18 per metre of track + endpiece	10
8	16	2.3	16	18 per metre of track + endpiece	11

Wave standard with roller gliders

Glider-cord spacing	Curtain hook spacing	Approx. curtain fullness	Stack depth (a)	Stack width (b)	Min distance (c)
8	14	2.1	14	21 per metre of track + endpiece	10
8	16	2.3	16	21 per metre of track + endpiece	11

(dimensions in cm)

Note: Minimum distance (c) includes a standard 3cm clearance (front and back).

## System Options

### Wave curtain heading system

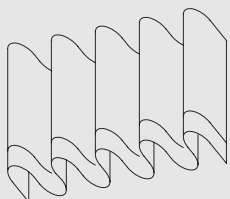

The Wave is an exciting contemporary curtain heading system which allows curtains to hang in a continuous wave which is smooth, simple and elegant.

The Wave standard components are:

- 6345 Glider Cord 60mm
- 6346 Glider Cord 80mm
- 6007 End stop

The items listed below are all supplied at an additional cost as per the price list.

Optional components to improve the presentation of the curtain:

- 3582 Hook
- 6349 Curtain tape
- 6363 Iron-on top hemming tape
- 10075 Lead weight for hem of curtain 50gr/m
- 10076 Fabric weight for side edge of curtain

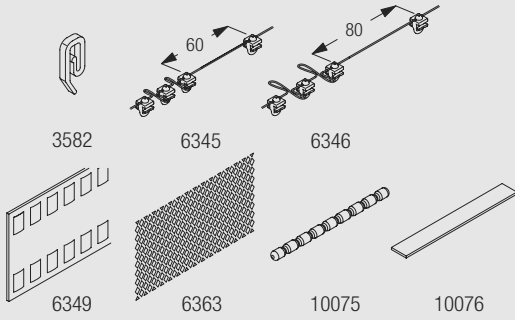

## Fitting Information

### Ceiling fixing with clamp 3825

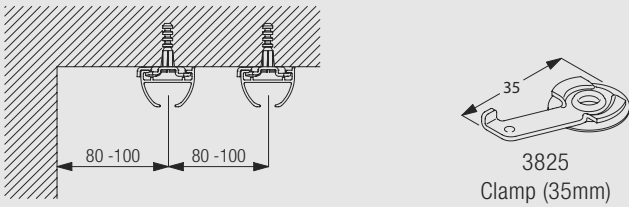

Fix track with at least one clamp 3825 every 300-600mm.  
Higher edge of profile to room side. The final distances depend on system height and width and the way of confectioning.

### Ceiling fix with bracket 3832

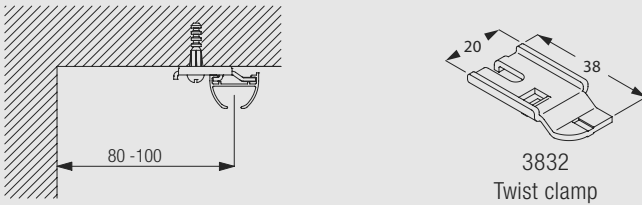

Fix track with at least one bracket 3832 every 300-600mm.  
Higher edge of profile to room side. The final distances depend on system height and width and the way of confectioning.

### Wall fitting with Smart Fix 11200-11205 and bracket 3832



Brackets feature thread for screw SG M4x8 for fixing bracket SG 3832.

## Wall fitting with Square Smart Fix 11210-11215 and bracket 3832

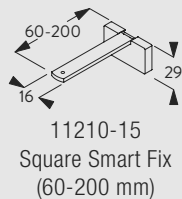
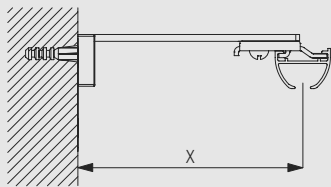

Brackets feature thread for screw SG M4x8 for fixing bracket SG 3832.

## Wall fitting with Universal Smart Fix 11154-11156 and bracket 3832

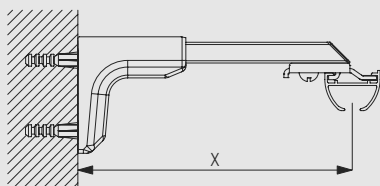

	X (mm)
11154	120-148
11155	150-178
11156	200-228

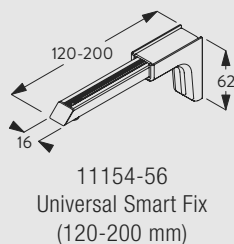

Brackets feature thread for screw SG M4x10 for fixing bracket SG 3832.

## Standard Accessories

3825 Clamp (35mm)



6010 Profile



6018 Endcover



6065 Twist eye endstop



6096 Glider 6083 in strip form



1148C Countersunk screw

6010

## Optional Accessories

3802 Connecting bridge

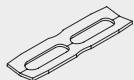

3832 Twist clamp

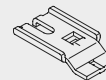

6098 Roller glider with eye



6283 Roller glider



11154 Universal Smart Fix, 120 mm set

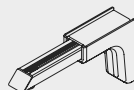

11155 Universal Smart Fix, 150 mm set

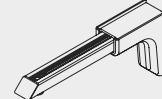

11156 Universal Smart Fix, 200 mm set

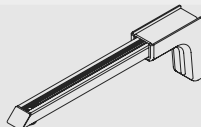

11200 Smart Fix, 60 mm set



11201 Smart Fix, 80 mm set



11202 Smart Fix, 100 mm set

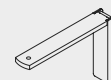

11203	Smart Fix, 120 mm set	
11205	Smart Fix, 200 mm set	
11211	Square Smart Fix, 80 mm set	
11213	Square Smart Fix, 120 mm set	
11215	Square Smart Fix, 200 mm set	

11204	Smart Fix, 150 mm set	
11210	Square Smart Fix, 60 mm set	
11212	Square Smart Fix, 100 mm set	
11214	Square Smart Fix, 150 mm set	

## Sewing and Wave Accessories

3582	Hook	
6346	Wave glider cord (80mm)	
6363	Top hemming tape	
10076	Fabric weight	

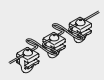
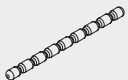
6345	Wave glider cord (60mm)	
6349	Curtain tape	
10075	Lead weight 50 gr/m	
6098W	Wave roller glider cord (80mm)	

## Useful Measures

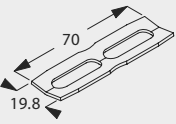
3802	Connecting bridge	
------	-------------------	---

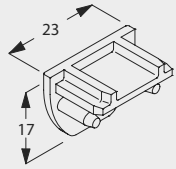
6018	Endcover	
------	----------	---

6010

[www.silentgliss.co.uk](http://www.silentgliss.co.uk)  
[www.silentglissglobal.com](http://www.silentglissglobal.com)

Silent Gliss Ltd  
Pyramid Business Park  
Poorhole Lane  
Broadstairs  
Kent  
CT10 2PT  
Great Britain

Tel: +44 (0) 1843 863571  
Fax: +44 (0) 1843 864503  
[info@silentgliss.co.uk](mailto:info@silentgliss.co.uk)

Silent Gliss Global Ltd  
Pyramid Business Park  
Poorhole Lane  
Broadstairs  
Kent  
CT10 2PT  
Great Britain

Tel: +44 (0) 1843 874250  
Fax: +44 (0) 1843 874457  
[info@silentglissglobal.com](mailto:info@silentglissglobal.com)