

Cord Operated Curtain Track Systems

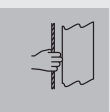



Heavy Duty and Stage Curtain Track System

Silent Gliss® 6370

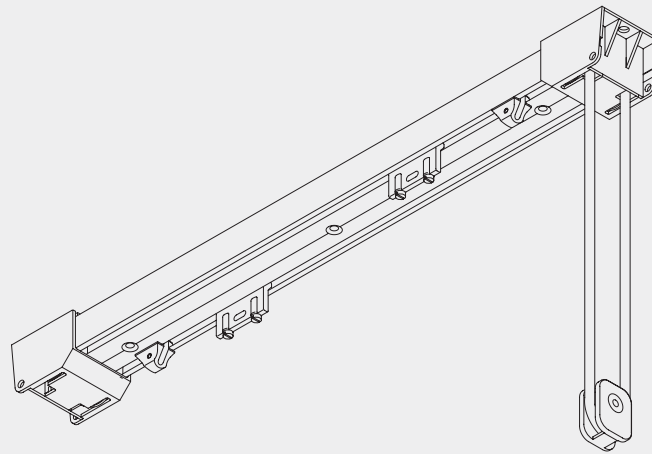

Product Information

- Discreet heavy-duty track system with twin channel for infinite overlap
- Cost effective system for small stages, very heavy contract and domestic use etc
- Heavy curtains up to 70kg, and width up to 15m
- Simple direct fixing, ceiling fix preferred. Drilled at approximately 500mm centres
- Profile available in 4, 5 and 6 metre lengths
- Satin silver finish as standard
- Can be bent



6370

Profile, Bending and Specification Information

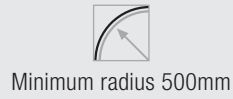
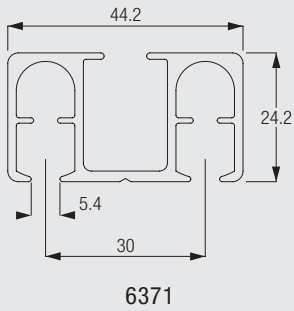

Specification Information - download from www.silentgliss.co.uk (password required).

Silent Gliss 6370 curtain track, cord operated, assembled complete with roller gliders 6098 at 10/m. cord 6070 right-hand side, ceiling fixed through profile at 500mm centres plus endpieces, each one screwed to timber/plugged and screwed to brickwork/concrete.Lm in lengths.

How to Measure

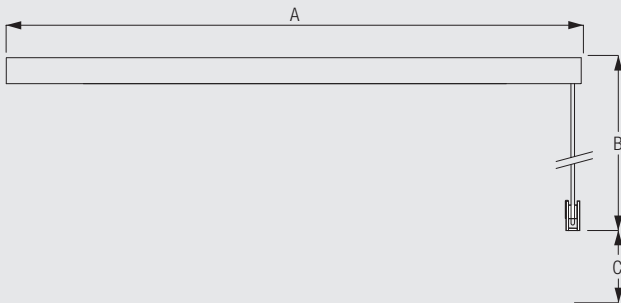

A: system width
 B: cord height
 C: cord retainer 10400 must be installed at least 150cm above the floor
 (ref: EN13120 Child Safety)

System Dimensions



6370



15 m



70 kg

Maximum curtain weight chart (with roller)

	3 m	6 m	9 m	12 m	15 m
	65	60	55	50	45
	70	65	60	55	50
	48	42	36	31	26
	54	48	42	36	30
	38	32	27	22	18
	44	38	32	27	22
	24	15	5	-	-
	27	19	10	-	-
(kg max.)					

Fitting Information

WARNING

Young children can be strangled by loops in pullcords, chains, tapes and inner cords that operate the product. To avoid strangulation and entanglement, keep cords out of the reach of young children. Cords may become wrapped around a child's neck. Move beds, cots and furniture away from window covering cords. Do not tie cords together. Make sure cords do not twist to create a loop.

Bracket positioning

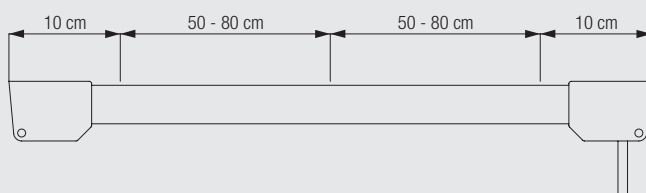

The fixing distances above are meant as a guide only, they may vary in practice depending on surface and curtain weight. For particularly heavy curtains the maximum recommended distance is 500mm.



6370

Fitting Options

CAD download through Silent Gliss website (password required) www.silentgliss.co.uk

Direct to ceiling fix through profile

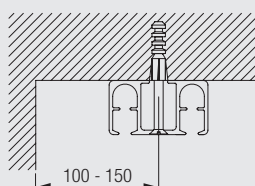

Recess fix through profile

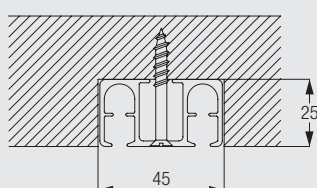

Wall fitting with Universal Smart Fix 11154-11156

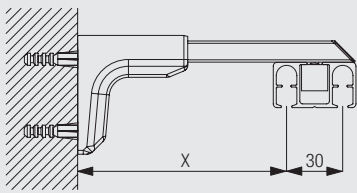

	X (mm)
11154	87-115
11155	117-145
11156	167-195

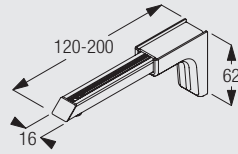

11154-56
Universal Smart Fix
(120-200 mm)

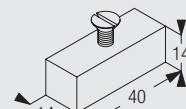

6369
Insert

Brackets feature thread for screw SG 11157 (M5x20) for fixing nut SG 6369. Universal Smart Fix only with open channel downside

Standard Accessories

18R Screw 25mm. No. 8 roundhead

6086 Spring stop



6214 Adjustable pilot (white)



6371 Profile



10400 Safety Cord Retainer



6070 Cord (ø 6mm)



6098 Roller glider with eye



6227 Master pilot runner (grey)



6377 Endpiece set (2 part)



1128C Countersunk screw



6370

Optional Accessories

6007 Endstop



6094 Roller glider with hook



6376 Connecting bridge



11155 Universal Smart Fix, 150 mm set

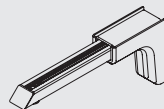

6079 Overlap arm



6369 Insert



11154 Universal Smart Fix, 120 mm set

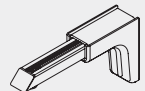

11156 Universal Smart Fix, 200 mm set

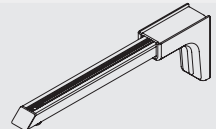

Sewing Information and Accessories

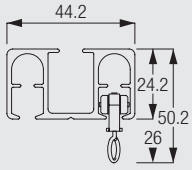

Diagram uses standard roller 6098 measured to the inside of the glider eye. For optional rollers substitute the dimensions below:

6094 = 31mm

3582 Hook



3599 Hook



6370

www.silentgliss.co.uk

www.silentglissglobal.com

Silent Gliss Ltd
Pyramid Business Park
Poorhole Lane
Broadstairs
Kent
CT10 2PT
Great Britain

Tel: +44 (0) 1843 863571
Fax: +44 (0) 1843 864503
info@silentgliss.co.uk

Silent Gliss Global Ltd
Pyramid Business Park
Poorhole Lane
Broadstairs
Kent
CT10 2PT
Great Britain

Tel: +44 (0) 1843 874250
Fax: +44 (0) 1843 874457
info@silentglissglobal.com