

# SG 8910

---

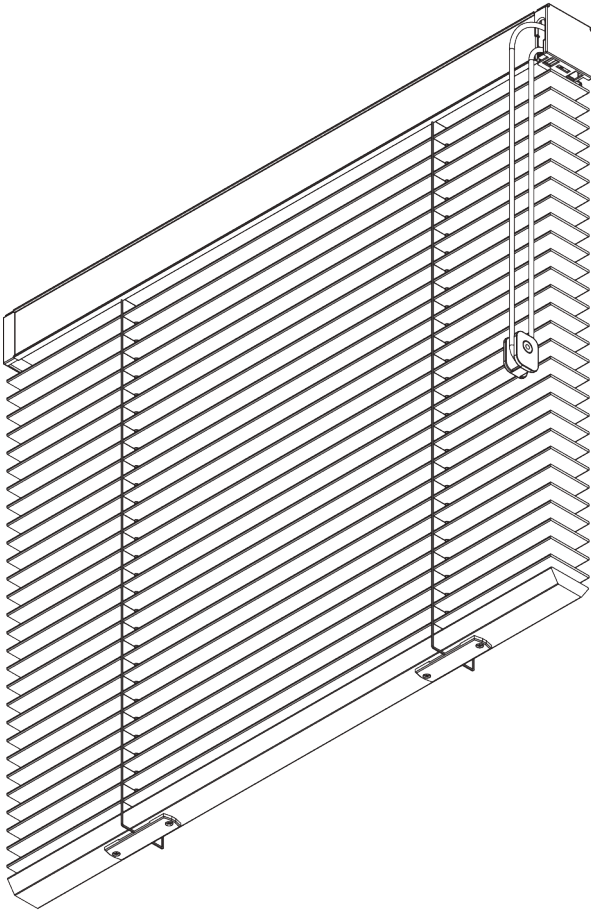
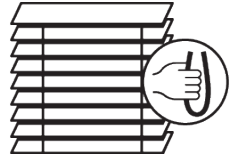

## PRODUCT INFORMATION

- **Operation:** cord
- **Range:** L
- **Fitting:** ceiling, wall
- **Colours:** refer to Silent Gliss slat collection

### **Features:**

- Optimised light control
- Speed controller: semi-automatic lowering of slats
- Wood, aluminium and leather slats
- Slat width: 50 mm
- Headrail slat cover
- Choice of ladder cord or decorative slat tape

07/2021/V1

# SYSTEM SPECIFICATIONS

## A. SYSTEM DIMENSIONS

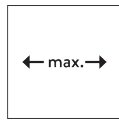

Wood / Leather: 2.4 m  
Aluminium: 3.6 m

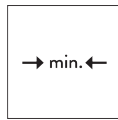

65 cm

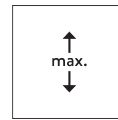

Wood / Leather: 2.75 m  
Aluminium: 3.6 m



Wood / Leather: 4.6 m<sup>2</sup>  
Aluminium: 10 m<sup>2</sup>

## Slat stack heights

Note: stack size will be larger when tapes are used

Wooden

	50 mm	X								
			60	90	120	150	180	210	240	275
			12	15	17	20	22	25	27	30

(cm)

Leather

	50 mm	X								
			60	90	120	150	180	210	240	275
			14	16	18	20	22	24	26	28

(cm)

Aluminium

	50 mm	X				
			100	200	300	360
			10	13	17	20

(cm)

## B. PROFILE

### Profile information

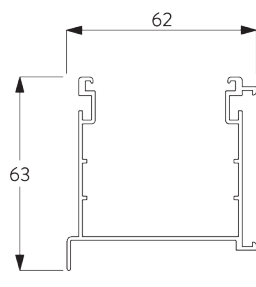

**SG 8902**

Profile

**C. HOW TO  
MEASURE**

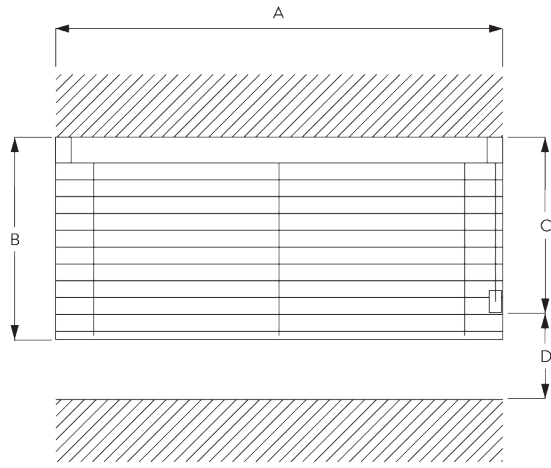

A: System width  
 B: System height  
 C: Cord height  
 D: Safety Retainer SG 10731 min. 150 cm above floor

**D. SPECIFICATION  
TEXT**

**Silent Gliss SG 8910 Cord Operated Venetian Blind System.** Supplied made to measure and complete comprising aluminium headrail SG 8902 incorporating matching colour slat, right or left-hand side single cord operation which permits raising, lowering and tilting of the slats. System fixed with universal brackets SG 8920 to ceiling or wall at 500mm intervals plus one at 100mm from each end. Compliant to Child Safety legislation EN 13120 when used in conjunction with Cord Retainer 10400. Slat colours to be chosen from Silent Gliss 50mm aluminium / wood / leather range.

**FITTING**

**A. FITTING  
INFORMATION**

For detailed fitting information, visit the Silent Gliss website.

**Fixing points**

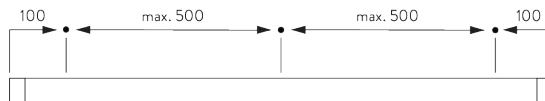

**B. CEILING FITTING**

**Bracket SG 8920**

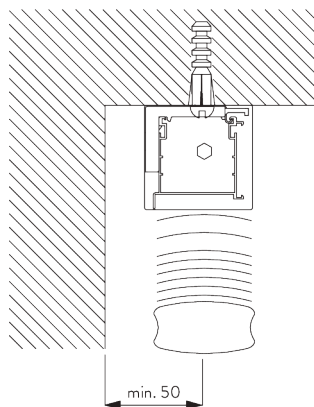

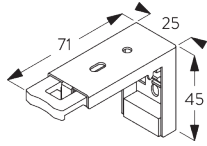

**SG 8920**

Bracket

**C. WALL FITTING**

Bracket SG 8920

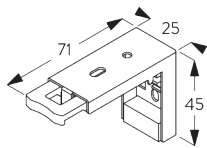
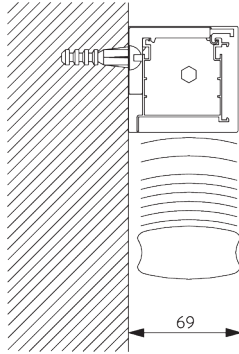

**SG 8920**

Bracket

**D. FITTING WITH  
SIDE GUIDE  
OPTION**

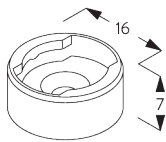
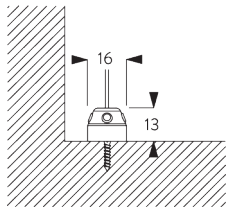

**SG 8235**

Side guide wire base short

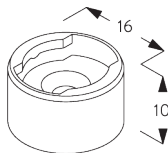

**SG 8236**

Side guide wire base long

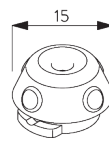

**SG 8237**

Side guide wire holder

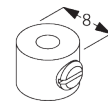

**SG 8249**

Side guide device

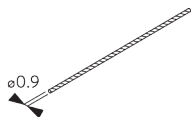

**SG 10120**

Side guide wire  $\varnothing$  0.9 mm

# SYSTEM OPTIONS

## A. HEADRAIL SLAT COVER

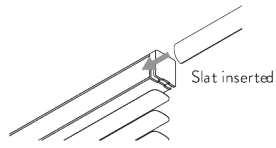

- A slat is inserted into the headrail for perfect matching of colours and materials to avoid the need to fit a cumbersome valance.
- For leather slat blinds there is the option of a leather covered headrail at an additional cost.
- Leather covered slats cannot be specified with decorative (external) slat tapes. The blind hardware is supplied matching the slat colour.

## B. SIDE GUIDES

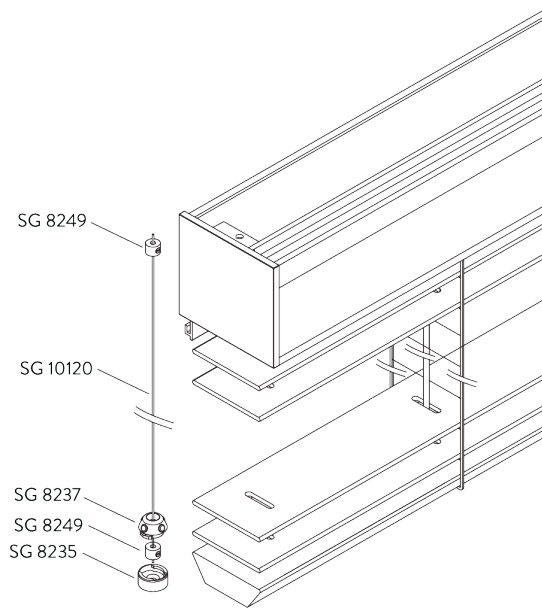

Additional parts:

- 2x SG 8235 Side guide wire base short
- 2x SG 8237 Side guide wire holder
- 4x SG 8249 Side guide device
- 2x SG 10120 Side guide wire  $\varnothing$  0.9 mm

Note:

- Up to 15° from vertical

# GENERAL NOTES

## **Dimensions**

- *Measurements are in mm except where indicated.*

## **Fitting**

- *Installation by qualified fitter only.*
- *Number of brackets and fitting positions / fixing points vary depending on fitting surface, system weight, slate type, screw / fixing type and obstacles.*
- *Qualified fitter must use appropriate screws / fixings for each situation.*
- *Profile lip if applicable to be installed to room side.*
- *Electrical installations must be carried out according to Silent Gliss wiring diagrams and conform to local regulations.*
- *Check space for cables and plugs!*

## **Child Safety**

- *All relevant Silent Gliss systems correspond to child safety EN 13120.*
- *All parties involved must comply with EN 13120.*

# PARTS

## A. STANDARD PARTS

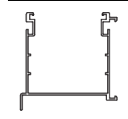

**SG 8902**

*Profile*

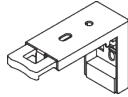

**SG 8920**

*Bracket*



**SG 10731**

*Child safety retainer set*

## B. OPTIONAL PARTS



**SG 8235**

*Side guide wire base short*



**SG 8236**

*Side guide wire base long*



**SG 8237**

*Side guide wire holder*

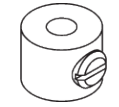

**SG 8249**

*Side guide device*



**SG 10120**

*Side guide wire ø 0.9 mm*

