

# SG 6100M

---

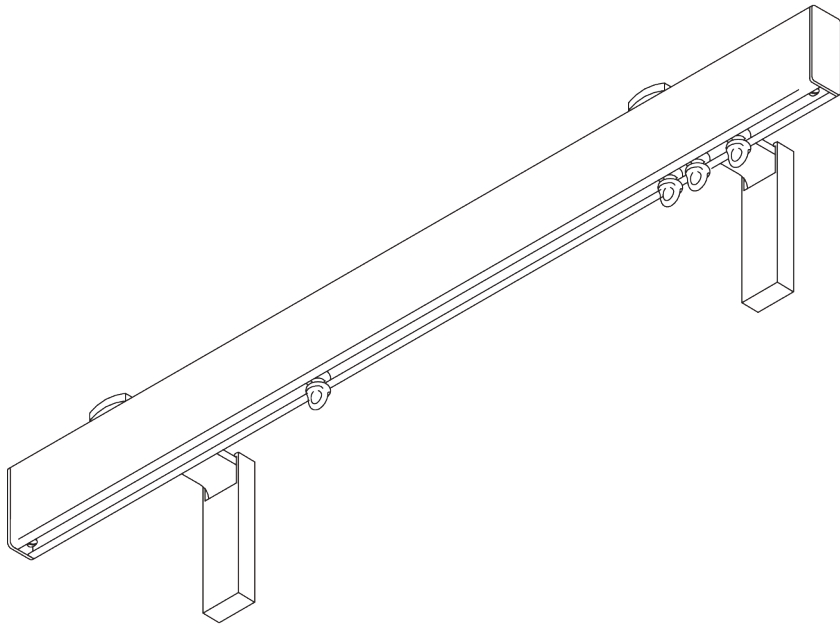
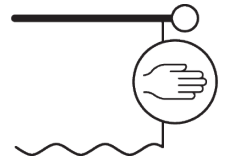

## PRODUCT INFORMATION

- **Operation:** hand
- **Range:** M - L
- **Fitting:** ceiling, wall
- **Colours:** white RAL 9016, various colours / finishes
- **Fabrics:** refer to Silent Gliss fabric collection

### **Features:**

- 2-component (2C) glider technology
- Wave (2C)
- Matching endcaps and brackets / bracket covers
- Range of decorative finials
- Bendable

# SYSTEM SPECIFICATIONS

## A. PROFILE

Profile and bending information

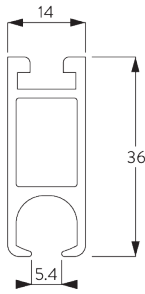

**SG 6101**

Profile



## B. HOW TO MEASURE

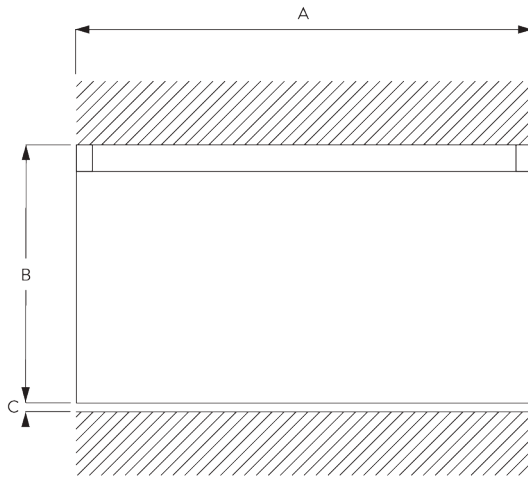

A: System width includes finials

B: System height

C: Distance between floor and fabric

## C. SPECIFICATION

### TEXT

**Silent Gliss SG 6100 'Metropole' hand operated curtain track system.** Comprises 36mm h x 14mm d aluminium profile SG 6100 supplied made to measure with 2C gliders SG 11300 at 14/m, 2 end flush covers SG 20351 and 2 no. end stops SG 6065. Straight poles supplied as standard with wall 'face' fix Smart Fix brackets SG 11206 at max. 600mm centres. Optional wall fix brackets SG11207-11208 / SG 11216-11218 / SG 11209 / Maxi bracket SG 20334 / Blok bracket SG 20989. Bent systems for wall 'face' fix supplied as standard with adjustable Smart Fix bracket SG 11209. Ceiling 'top' fix with bracket SG 6151 / SG 20335 at max. 600mm centres. Finished in Antique Bronze, Gunmetal, Black, Charcoal, Anodic Grey, Slate Grey, Matt White, White, Chrome Effect or Anodised Silver. A range of decorative finials are available. Silent Gliss Wave option is available using 60mm glider cord SG 11303/80mm glider cord SG 11302/80mm roller glider cord SG 6099.

# FITTING

## A. FITTING INFORMATION

For detailed fitting information, visit the Silent Gliss website.

### Fixing points

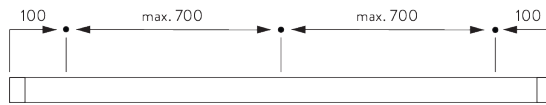

## B. CEILING FITTING

### Support SG 6151

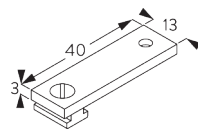
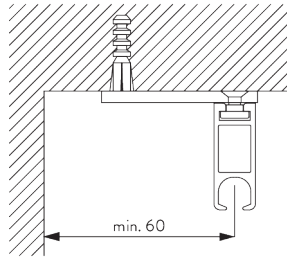

#### SG 6151

Ceiling support set 3 mm

### Top fix bracket SG 20335

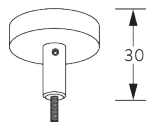
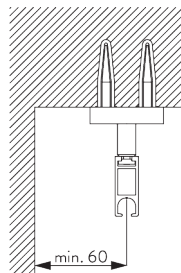

#### SG 20335

Top fix bracket

## C. WALL FITTING

### Smart Fix

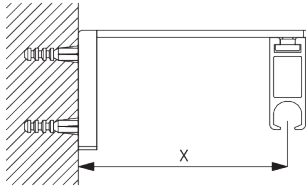

**Smart Fix with slot SG 11206 - SG 11208 and SG 6141:**  
Screw SG 20798 (M4x10) needed.

Smart Fix	X mm
SG 11206 / SG 11216	51
SG 11207 / SG 11217	71
SG 11208 / SG 11218	91
SG 11209 / SG 11472	80-100

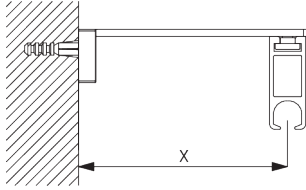

**Square Smart Fix with slot SG 11216 - SG 11218 and SG 6141:**  
Screw SG 20798 (M4x10) needed.

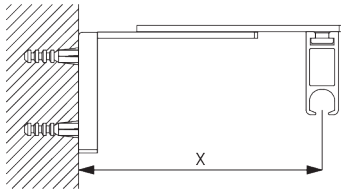

**Adjustable Smart Fix SG 11209 and SG 6141:**  
Screw SG 6784 (M4x8) needed.

*Note: all bent Metropole systems are supplied with adjustable bracket SG 11209 as standard.*

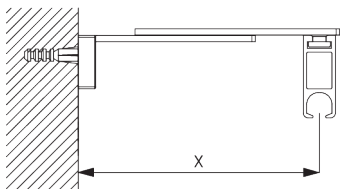

**Adjustable Square Smart Fix SG 11472 and SG 6141:**  
Screw SG 6784 (M4x8) needed.

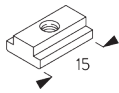

**SG 6141**  
Clamping piece



**SG 6784**  
Hexagon socket countersunk screw M4x8 mm

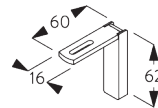

**SG 11206**  
Smart Fix with slot 60 mm

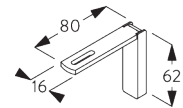

**SG 11207**  
Smart Fix with slot 80 mm

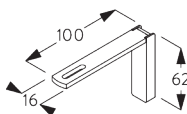

**SG 11208**  
Smart Fix with slot 100 mm

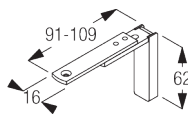

**SG 11209**  
Adjustable Smart Fix

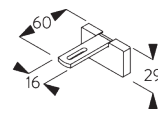

**SG 11216**  
Square Smart Fix with slot 60 mm

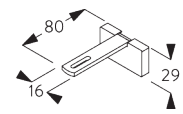

**SG 11217**  
Square Smart Fix with slot 80 mm

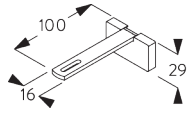

**SG 11218**

Square Smart Fix with slot  
100 mm

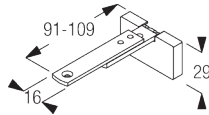

**SG 11472**

Adjustable Square Smart Fix



**SG 20798**

Hexagon socket countersunk  
screw M4x10 mm

**Blok bracket  
SG 20989**

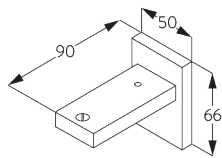
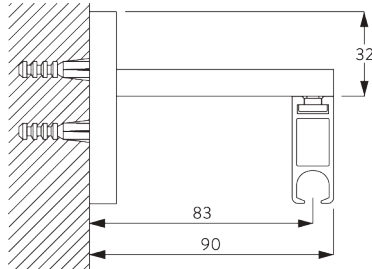

**SG 20989**

Blok bracket

## DESIGN & SYSTEM OPTIONS

### A. ENDCAPS

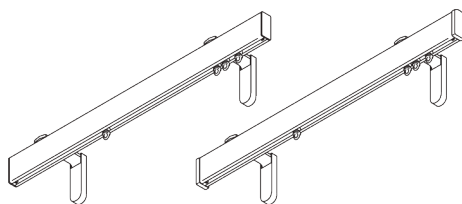

Without finials, poles are supplied as standard with flush fitting endcaps SG 20351 (left).

Alternatively, stud endcaps SG 20710 (right) can be selected at no additional cost.

### B. FINIALS

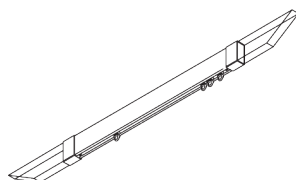

Finials are decorative elements that fit on at the end of the pole.

Please refer to the *Metropole brochure* for full range details.

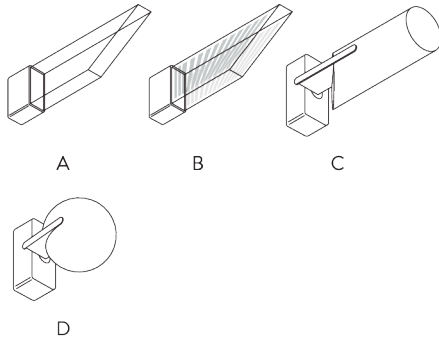

- A: SG 20991 Shard 116 mm (clear)
- B: SG 20991 Shard 116 mm (etched)
- C: SG 20304 Fused Barrel 102 mm (walnut, oak, colour matched)
- D: SG 20318 Fused Ball 63 mm (walnut, oak, colour matched)

## C. WAVE

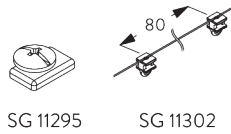
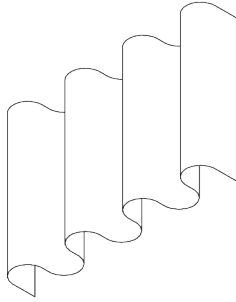

- Standard components:
- SG 11295 End stop
  - SG 11302 Wave 2C glider cord 80 mm

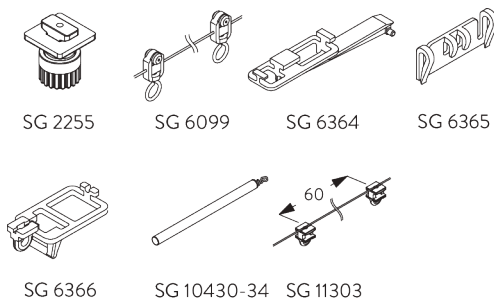

- Optional components:
- SG 2255 Brake
  - SG 6099 Wave roller cord 80 mm
  - SG 6364 Wave extension
  - SG 6365 Wave hanger
  - SG 6366 Wave carrier for draw rod
  - SG 10430-34 Draw rod
  - SG 11303 Wave 2C glider cord 60 mm

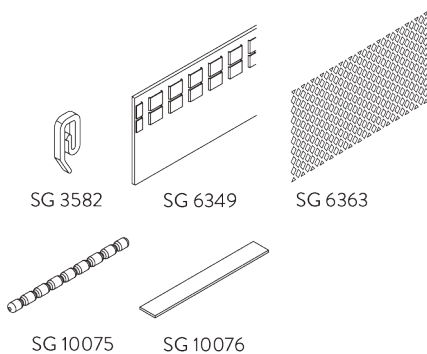

- Curtain components:
- SG 3582 Hook
  - SG 6349 Wave curtain tape
  - SG 6363 Wave top hemming tape
  - SG 10075 Lead weight 50 gr/m
  - SG 10076 Fabric weigh

Wave stack depth - 2C glider cord (standard components)

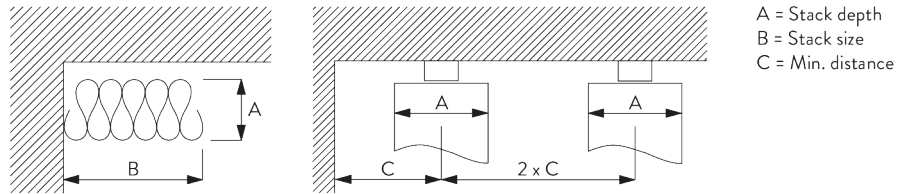

2C Glider cord SG 11302	Pockets between hooks	Approx. curtain fullness	Stack depth A	Stack size B*	Min distance C
80	6	~2.1	140	180 per metre of track	90
80	7	~2.3	160	180 per metre of track	100

2C Glider cord SG 11303	Pockets between hooks	Approx. curtain fullness	Stack depth A	Stack size B*	Min distance C
60	4	~2.1	100	230 per metre of track	70
60	5	~2.3	120	230 per metre of track	80

\*Stack size B when using optional extension arm  
SG 6364 increases by 95 mm per curtain stack!

## GENERAL NOTES

### Dimensions

- Measurements are in mm except where indicated.
- Max. kg relates to fabric incl. accessories.
- Stack size depends on curtain make-up and fabric thickness.
- Distance between gliders max. 80 mm / distance between rollers max. 100 mm.
- Recommended distance floor / fabric: 20 mm.
- In order to determine system height (B), the smallest room height must be taken into account.

### Fitting

- Installation by qualified fitter only.
- Number of brackets and fitting positions / fixing points vary depending on fitting surface, system weight, fabric make-up, screw / fixing type and obstacles.
- Qualified fitter must use appropriate screws / fixings for each situation.
- Profile lip if applicable to be installed to room side.

### Child Safety

- All relevant Silent Gliss systems correspond to child safety EN 13120.
- All parties involved must comply with EN 13120.

# PARTS

## A. STANDARD PARTS

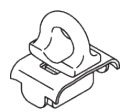

**SG 6065**  
End stop



**SG 6101**  
Profile



**SG 6141**  
Clamping piece

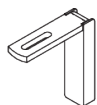

**SG 11206**  
Smart Fix with slot 60 mm

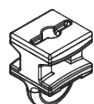

**SG 11300**  
2C glider

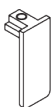

**SG 20351**  
Metroflat endcap

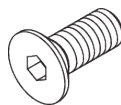

**SG 20798**  
Hexagon socket countersunk screw  
M4x10 mm

## B. OPTIONAL PARTS



**SG 2216**  
Cord  $\varnothing$  0.85 mm

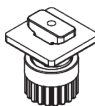

**SG 2255**  
Brake



**SG 3582**  
Hook

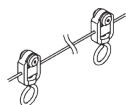

**SG 6099**  
Wave roller cord 80 mm

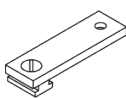

**SG 6151**  
Ceiling support set 3 mm



**SG 6283**  
Roller



**SG 6349**  
Wave curtain tape

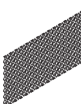

**SG 6363**  
Wave top hemming tape

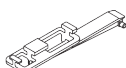

**SG 6364**  
Wave extension



**SG 6365**  
Wave hanger

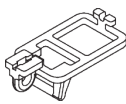

**SG 6366**  
Wave carrier for draw rod

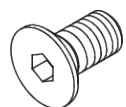

**SG 6784**  
Hexagon socket countersunk screw  
M4x8 mm



**SG 10075**  
Lead weight 50 g/m



**SG 10076**  
Fabric weight

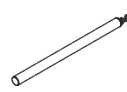

**SG 10430**  
Draw rod 50 cm

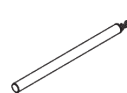

**SG 10431**  
Draw rod 75 cm

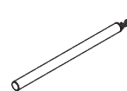

**SG 10432**  
Draw rod 100 cm

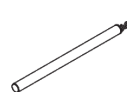

**SG 10433**  
Draw rod 125 cm

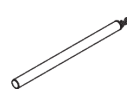

**SG 10434**  
Draw rod 150 cm

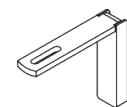

**SG 11207**  
Smart Fix with slot 80 mm

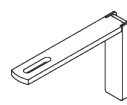

**SG 11208**  
Smart Fix with slot 100 mm

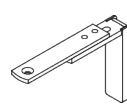

**SG 11209**  
Adjustable Smart Fix

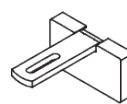

**SG 11216**  
Square Smart Fix with slot 60 mm

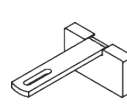

**SG 11217**  
Square Smart Fix with slot 80 mm

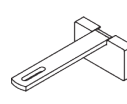

**SG 11218**  
Square Smart Fix with slot 100 mm

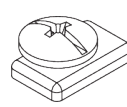

**SG 11295**  
End stop



**SG 11301**  
2C glider on strip

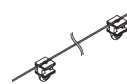

**SG 11302**  
Wave 2C glider cord 80 mm



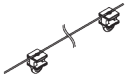

---

**SG 11303**

Wave 2C glider cord 60 mm

---

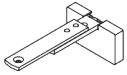

---

**SG 11472**

Adjustable Square Smart Fix

---

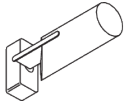

---

**SG 20304**

Fused barrel 102 mm

---

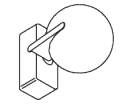

---

**SG 20318**

Fused ball 63 mm

---



---

**SG 20335**

Top fix bracket

---

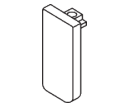

---

**SG 20710**

Stud endcap

---

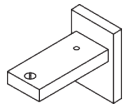

---

**SG 20989**

Blok bracket

---

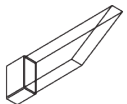

---

**SG 20991**

Shard 116 mm

---





