

SG 6820

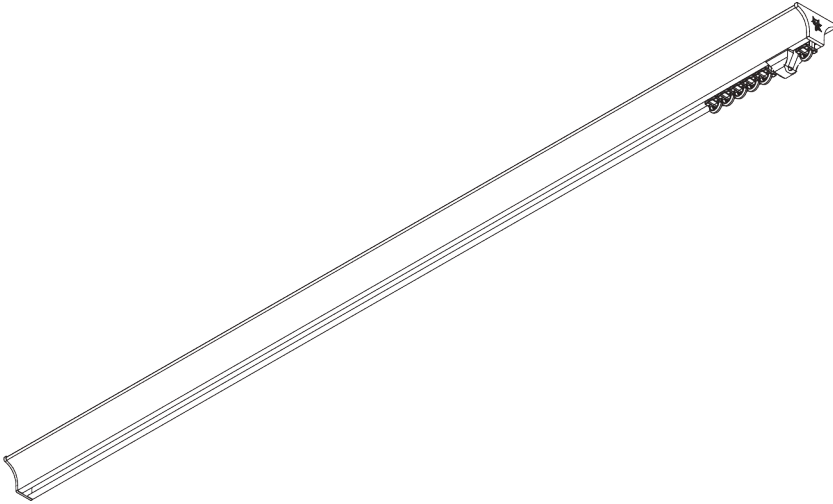

PRODUCT INFORMATION

- **Operation:** hand
- **Range:** S - M
- **Fitting:** ceiling
- **Colours:** white RAL 9016; special colours or anodised aluminum possible
- **Fabrics:** refer to Silent Gliss fabric collection

Features:

- 2-component (2C) glider technology
- Wave (2C)
- Symmetrical funnel design
- Bendable

SYSTEM SPECIFICATIONS

A. SYSTEM DIMENSIONS

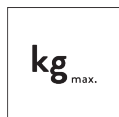

10 kg

B. PROFILE

Profile and bending information

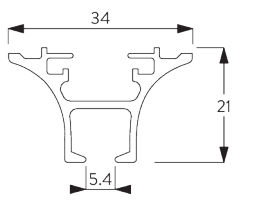

SG 6821

Profile Funnel



C. HOW TO MEASURE

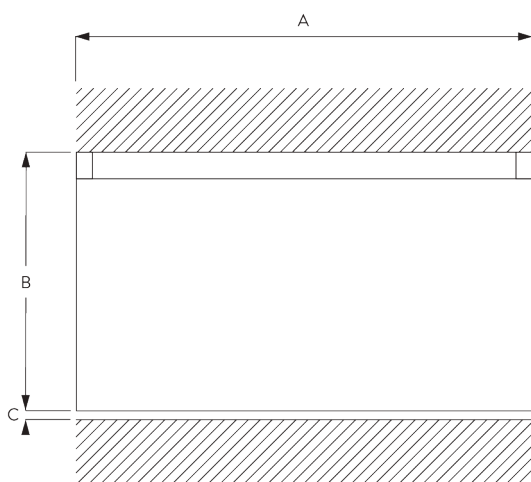

A: System width

B: System height

C: Distance between floor and fabric

D. SPECIFICATION TEXT

Silent Gliss SG 6820 Hand Operated Curtain Track System. Comprises aluminium profile SG 6821 made to measure powder coated white, with gliders SG 11300 at 14/m and 2 end covers SG 6823 and 2 end stops SG 6065 per length. Top fixed with clip brackets SG 11236 at 500mm centres. Silent Gliss Wave option is available using 60mm glider cord 11303 / 80mm glider cord 11302.

FITTING

A. FITTING INFORMATION

For detailed fitting information, visit the *Silent Gliss* website.

Fixing points

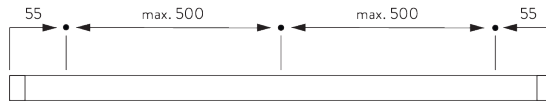

Fitting Tool

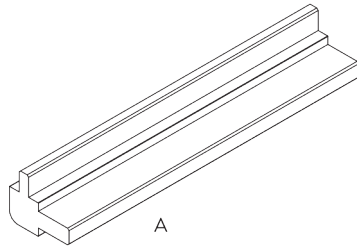

A: Funnel fitting tool SG 6827

For fitting / removing of the funnel profile.

B. CEILING FITTING

Clip SG 11236

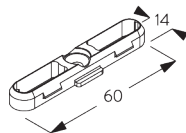
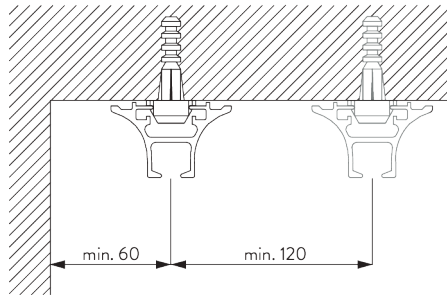

SG 11236

Clip

SYSTEM OPTIONS

A. WAVE

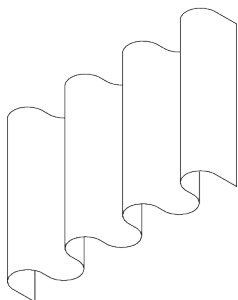

SG 11295

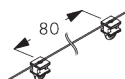

SG 11302



SG 2255

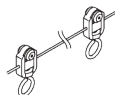

SG 6099

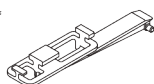

SG 6364



SG 6365

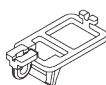

SG 6366

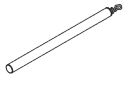

SG 10430-34

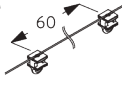

SG 11303

Standard components:

- SG 11295 End stop
- SG 11302 Wave 2C glider cord 80 mm

Optional components:

- SG 2255 Brake
- SG 6099 Wave roller cord 80 mm
- SG 6364 Wave extension
- SG 6365 Wave hanger
- SG 6366 Wave carrier for draw rod
- SG 10430-34 Draw rod
- SG 11303 Wave 2C glider cord 60 mm



SG 3582

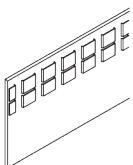

SG 6349

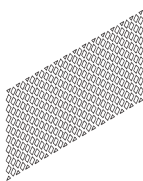

SG 6363

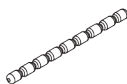

SG 10075



SG 10076

Curtain components:

- SG 3582 Hook
- SG 6349 Wave curtain tape
- SG 6363 Wave top hemming tape
- SG 10075 Lead weight 50 gr/m
- SG 10076 Fabric weight

Wave stack depth - 2C glider cord (standard components)

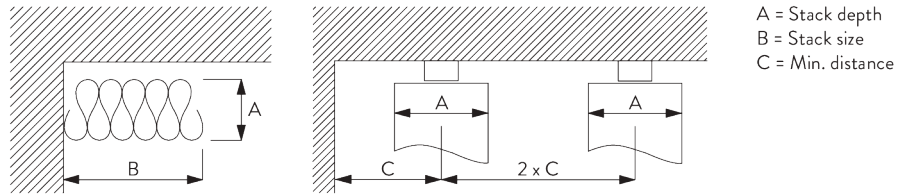

2C Glider cord SG 11302	Pockets between hooks	Approx. curtain fullness	Stack depth A	Stack size B*	Min distance C
80	6	~2.1	140	180 per metre of track	90
80	7	~2.3	160	180 per metre of track	100

2C Glider cord SG 11303	Pockets between hooks	Approx. curtain fullness	Stack depth A	Stack size B*	Min distance C
60	4	~2.1	100	230 per metre of track	70
60	5	~2.3	120	230 per metre of track	80

*Stack size B when using optional extension arm SG 6364 increases by 95 mm per curtain stack!

GENERAL NOTES

Dimensions

- Measurements are in mm except where indicated.
- Max. kg relates to fabric incl. accessories.
- Stack size depends on curtain make-up and fabric thickness.
- Distance between gliders max. 80 mm / distance between rollers max. 100 mm.
- Recommended distance floor / fabric: 20 mm.
- In order to determine system height (B), the smallest room height must be taken into account.

Fitting

- Installation by qualified fitter only.
- Number of brackets and fitting positions / fixing points vary depending on fitting surface, system weight, fabric make-up, screw / fixing type and obstacles.
- Qualified fitter must use appropriate screws / fixings for each situation.
- Profile lip if applicable to be installed to room side.

Child Safety

- All relevant Silent Gliss systems correspond to child safety EN 13120.
- All parties involved must comply with EN 13120.

PARTS

A. STANDARD PARTS



SG 6065

End stop



SG 6821

Profile Funnel



SG 6823

End cover

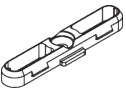

SG 11236

Clip



SG 11300

2C glider

B. OPTIONAL PARTS

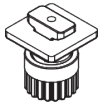

SG 2255

Brake



SG 3582

Hook



SG 3599

Hook

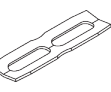

SG 3802

Connection bridge



SG 6053

Spring stop



SG 6086

Spring stop



SG 6094

Roller



SG 6098

Roller

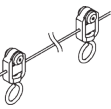

SG 6099

Wave roller cord 80 mm



SG 6146

Hook



SG 6283

Roller



SG 6349

Wave curtain tape



SG 6363

Wave top hemming tape

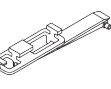

SG 6364

Wave extension

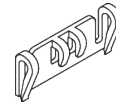

SG 6365

Wave hanger

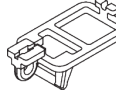

SG 6366

Wave carrier for draw rod



SG 10075

Lead weight 50 g/m

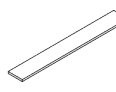

SG 10076

Fabric weight

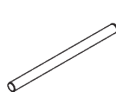

SG 10430

Draw rod 50 cm

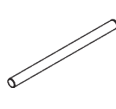

SG 10431

Draw rod 75 cm

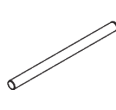

SG 10432

Draw rod 100 cm

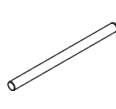

SG 10433

Draw rod 125 cm

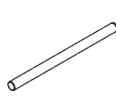

SG 10434

Draw rod 150 cm

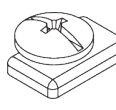

SG 11295

End stop



SG 11301

2C glider on strip

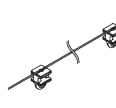

SG 11302

Wave 2C glider cord 80 mm

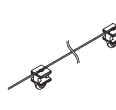

SG 11303

Wave 2C glider cord 60 mm

