

SG 1070

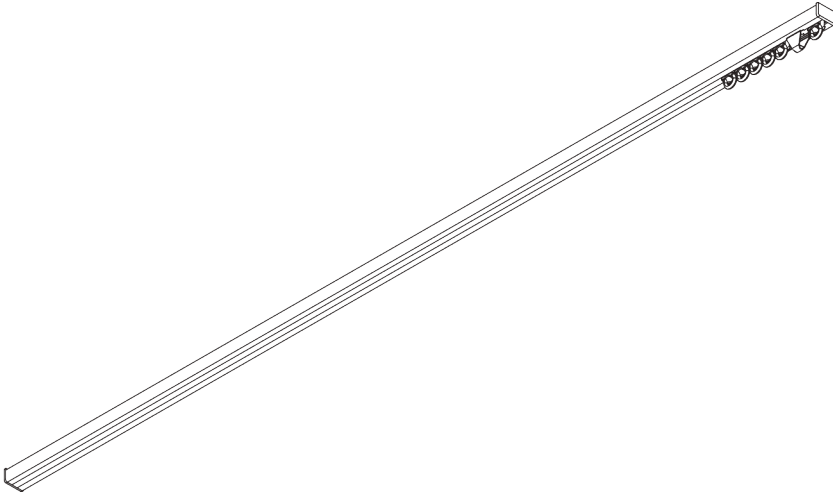

PRODUCT INFORMATION

- **Operation:** hand
- **Range:** S
- **Fitting:** ceiling
- **Colours:** white RAL 9016; special colours or anodised aluminum possible
- **Fabrics:** refer to Silent Gliss fabric collection

Features:

- Bendable

SYSTEM SPECIFICATIONS

A. PROFILE

Profile and bending information

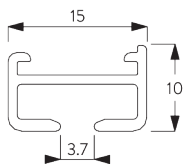

SG 1071

Profile

Radius:
✓ 8 cm, 12 cm, 16 cm,
>25 cm

B. HOW TO MEASURE

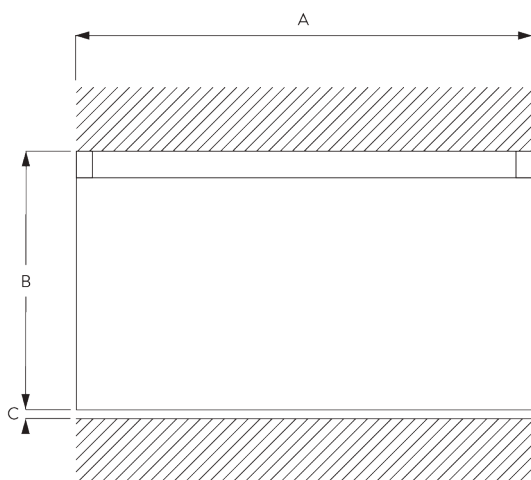

A: System width
B: System height
C: Distance between floor and fabric

C. SPECIFICATION TEXT

Silent Gliss SG 1070 Hand Operated Curtain Track System. Comprises aluminium profile SG 1071 supplied made to measure powder coated white, with gliders SG 3533 at 14/m and 2 end covers SG 1072 and 2 end stops SG 3016 per length. Top fixed with clamps SG 3060 at max. 300 mm centres.

FITTING

A. FITTING INFORMATION

Fixing points

For detailed fitting information, visit the Silent Gliss website.

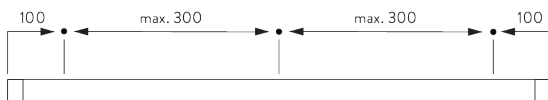

B. CEILING FITTING

Clamp SG 3060

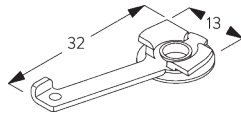
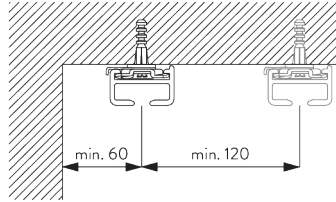

SG 3060

Clamp

GENERAL NOTES

Dimensions

- Measurements are in mm except where indicated.
- Max. kg relates to fabric incl. accessories.
- Stack size depends on curtain make-up and fabric thickness.
- Distance between gliders max. 80 mm / distance between rollers max. 100 mm.
- Recommended distance floor / fabric: 20 mm.
- In order to determine system height (B), the smallest room height must be taken into account.

Fitting

- Installation by qualified fitter only.
- Number of brackets and fitting positions / fixing points vary depending on fitting surface, system weight, fabric make-up, screw / fixing type and obstacles.
- Qualified fitter must use appropriate screws / fixings for each situation.
- Profile lip if applicable to be installed to room side.

Child Safety

- All relevant Silent Gliss systems correspond to child safety EN 13120.
- All parties involved must comply with EN 13120.

PARTS

A. STANDARD PARTS

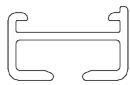

SG 1071

Profile

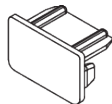

SG 1072

End cover



SG 3016

End stop

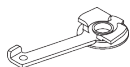

SG 3060

Clamp



SG 3533

Glider

B. OPTIONAL PARTS



SG 3062

Connection bridge



SG 3511

Glider



SG 3534

Glider 3533 on strip

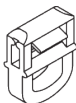

SG 3548

Glider



SG 3570

Glider

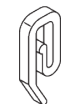

SG 3582

Hook



SG 3599

Hook

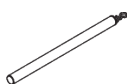

SG 10430

Draw rod 50 cm

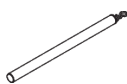

SG 10431

Draw rod 75 cm

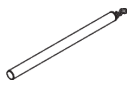

SG 10432

Draw rod 100 cm

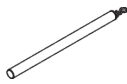

SG 10433

Draw rod 125 cm

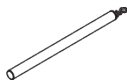

SG 10434

Draw rod 150 cm

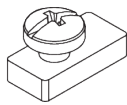

SG 11335

End stop